

# EE Times

## europa

For the creators of technology

# Validating test evidence to reduce supply chain risk

Executive interview:  
Plessey's new strategy

Special focus:  
RFID Technologies



**FREE  
SHIPPING**  
ON ORDERS  
OVER €65!



**DIGIKEY.COM/EUROPE**

# BEST of CLASS!

Which single distributor comes to mind as being 'best of class' for broadest overall product selection?

SOURCE: 2011 DESIGN ENGINEER AND SUPPLIER INTERFACE STUDY, HEARST BUSINESS MEDIA ELECTRONICS GROUP

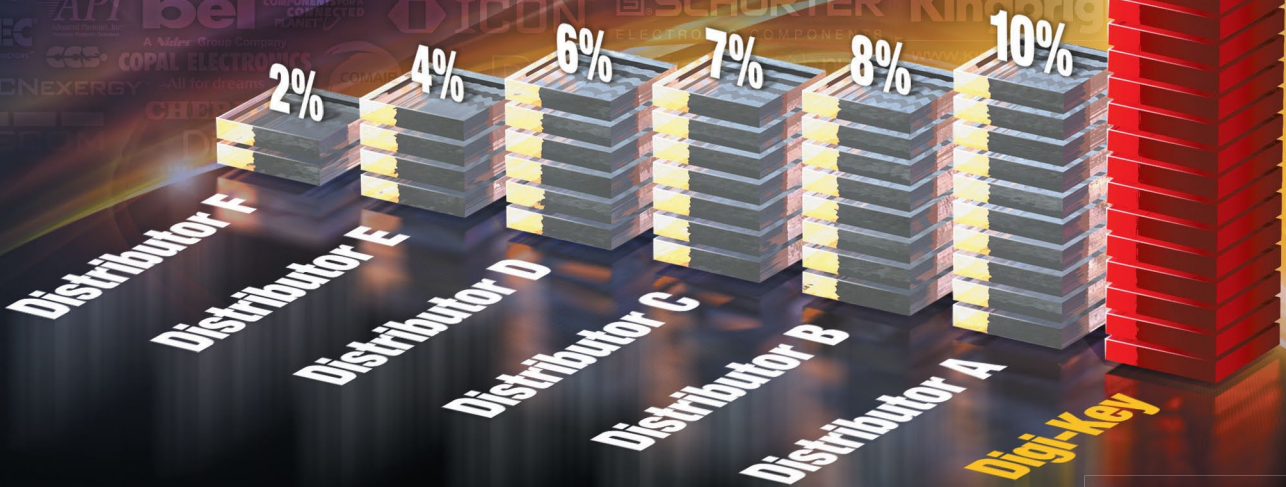

**FREE SHIPPING**  
ON ORDERS OVER €65!

FIND CONTACT AND ORDERING INFORMATION FOR YOUR REGION AT

**DIGIKEY.COM/EUROPE**

2.5 MILLION PARTS ONLINE | 650+ INDUSTRY-LEADING SUPPLIERS | NEW PRODUCTS ADDED DAILY

\*A shipping charge of €18.00 (£12.00) will be billed on all orders of less than €65.00 (£50.00). All orders are shipped via UPS for delivery within 1-3 days (dependent on final destination). No handling fees. All prices are in euro and British pound sterling. If excessive weight or unique circumstances require deviation from this charge, customers will be contacted prior to shipping order. Digi-Key is an authorized distributor for all supplier partners. New product added daily. © 2013 Digi-Key Corporation, 701 Brooks Ave. South, Thief River Falls, MN 56701, USA



## OPINION

- 4 Uncommon Market: Teacher's corner; circuit building for kids
- 50 Last Word: Driving innovation into the global automotive supply chain

## NEWS & TECHNOLOGY

- 6 BMW brings LTE connectivity to its vehicles and others
- Volvo, Ericsson jointly connect cars to the cloud
- 8 London Calling: A northern light startup

### Supercapacitors enter the realm of stretchable electronics

According to the University of Delaware's Bingqing Wei, stretchable electronics are the future of mobile electronics, leading giants such as IBM, Sony and Nokia to incorporate the technology into their products.

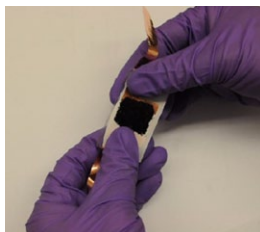

### Seeing the light

A focus on sensors for health equipment and high brightness LEDs may seem two very different markets, but the chief executive of Plessey Semiconductors sees them as key opportunities for the growth of the company over the next few years.

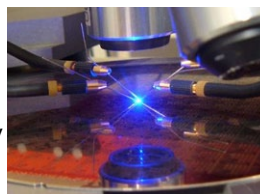

### Silicon-based optical fiber with solar-cell capabilities could be woven into solar fabrics

#### Energy-harvesting textile integrates micro spherical solar cells

In cooperation with the Industrial Technology Center of Fukui Prefecture, Japan, Sphelar Power Corporation has successfully prototyped an energy-harvesting textile where spherical solar cells are interweaved.

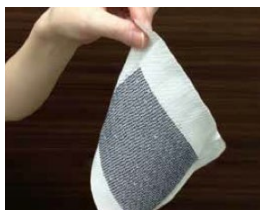

- 14 Lighting out of the printer  
As OLEDs are approaching industry maturity, lighting company Osram announced light emitting fibres produced in a printing process.



Toshiba starts GaN-on-Si LED production

## DESIGN & PRODUCTS

### SPECIAL FOCUS: - TEST & MEASUREMENT

- 15 Troubleshooting and verifying 8b/10b encoded signals with a real-time oscilloscope.
- 18 Near field analysis for EMI/EMC  
EMI/EMC characterization is essential for many electronics products. The high-speed signals may induce not only signal integrity and power integrity issues, but also cause radiation and electromagnetic interference problem.
- 20 Validating test evidence to reduce supply chain risk  
To meet the demand for low-cost goods, companies are increasingly buying directly from manufacturers outside the EU. While such products must bear the CE marking, this is not a sign of safety or compliance.
- 29 "Green" pathways for test, measurement and instrumentation  
Long ago, precision electrical measurements were performed in pristine laboratory environments where ample electricity was available and time was allotted to assure extreme accuracy.

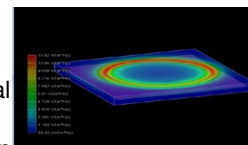

### - CONNECTORS & CABLING

- 34 Readying copper cable technicians to install optical fibres
- 36 The advantages of hyperboloid contact technology

### - RFID TECHNOLOGIES

- 40 Identifying UHF RFID tag design weaknesses  
UHF RFID tags put on the market should all be compliant with the standard EPC gen 2. Nevertheless the performances can be very different from one tag to another.
- 42 Active RFID systems that combine robust RF performance and low power consumption
- 44 Enhanced RFID realizes its full potential

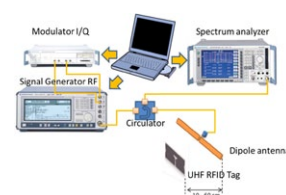

### READER OFFER

- 46 This month, Vision Engineering is giving away two of its recently launched CamZ digital magnifiers, worth £696 each.



### 49 DISTRIBUTION CORNER

# Teacher's corner; circuit building for kids

By David Peins

**FINDING WAYS TO HELP** young future engineers work with all of this new, inexpensive, very cool technology has become a full time job and not always an easy one.

Last week was a little distracting with all the destruction in the wake of hurricane Sandy; delayed deliveries, disrupted communications and some critical situations for family caused by prolonged power outages, but the work goes on.

While traveling to teach my PIC Robots class, I was rerouted numerous times due to power outages and downed trees. Seeing neighbors out clearing huge branches from the roofs of their houses and piles of uprooted trees lining the streets confirmed that the winds howling around my house had indeed been quite high. Still, I was very lucky and a few inconveniences are nothing compared to others' misery.

I found myself wishing that I had built a data logger to measure wind velocity – and realized that I could teach the kids how to develop code for their PIC controllers to do this. With that in mind, I ordered an Arduino Pro Mini 328 - 5V/16MHz from RobotShop to sit on top of our RAMP II (maybe we should start calling it a 'Shield').

Of course, simply giving kids a really cool black box is not the same thing as teaching them how to apply it to a problem. That's why working with 10, 11 and 12 year-olds is such a pleasure.

They are more easily convinced than my college kids that they don't actually know everything and they are genuinely excited when their code causes their circuit to behave as planned.

I also invoke the 'Magic Smoke' legend to enlighten them further. For my readers who are not familiar with this principle, "All electronic devices have 'Magic Smoke' that makes them work and if you connect these devices incorrectly, they will lose their 'Magic Smoke' – you will smell it and you may even see it.

Once you have let out the 'Magic Smoke', you can never put it back..."

I am always amazed when kids imagine that there are dozens of ways to connect wires to devices, and just have to try them all. Kids, if allowed to do so, will just start connecting wires randomly to see what happens.

While plugging these strange new objects into receptacles that may accept them may be fun for a very short time, I always make sure to tell my students the risks; namely that it will not yield much useful information and could very well be dangerous or deadly, not to mention wasteful. I am an empiricist so my methods generally endorse this kind of behavior but without understanding, there are limits.

---

David Peins teaches children as young as eight years old to read schematics, create working circuits on breadboards, program embedded controllers with MikroBasic and to program their own autonomous mobile robots to play 'Robot Sumo.'

Any instructional approach needs to present material in a contextual way so that students develop understanding. Someone recently re-tweeted the old adage, 'Knowing all of the facts is not the same as understanding the principles...' which illustrates the importance of relevant, contextual assessment to ensure understanding.

Having a context for the concepts encourages the effort required to learn the necessary material. Knowing which information to present to arrive at an educational goal, setting those goals and assessing students' progress with some sort of authentic (relevant) instrument are all essential to assure that, going forward, students will have the necessary intellectual tools to develop understanding.

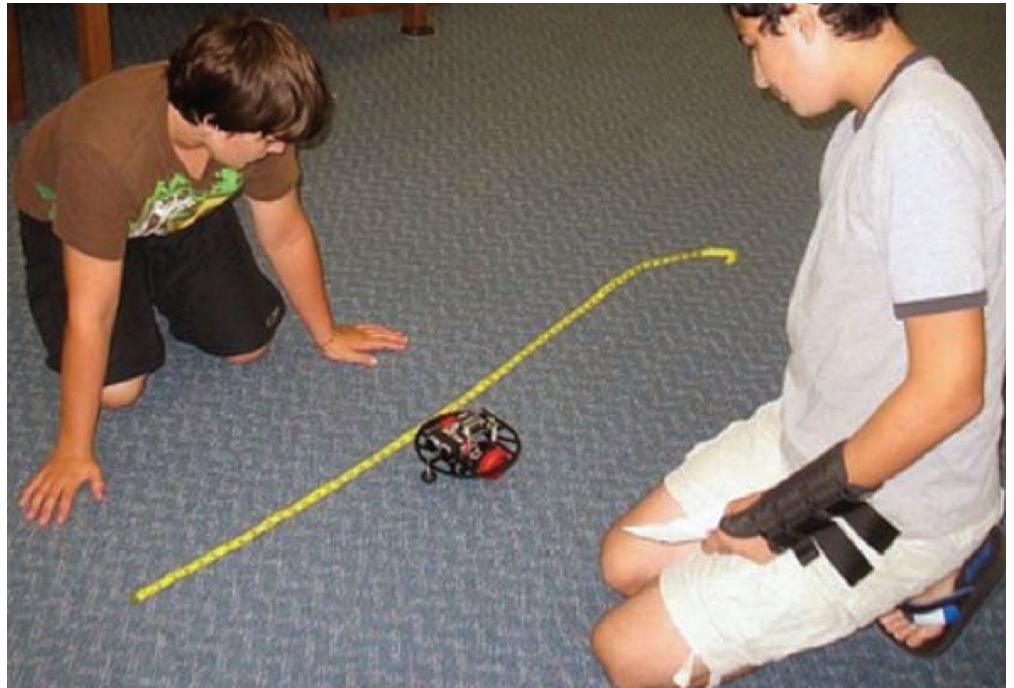

Finally, what might be a teachers' most important task is to inspire and to give learners the means of finding the tools to discover more.

I am encouraged by the suggestions in this Ericsson video I found online, ([http://www.ericsson.com/thinkingahead/networked\\_society/learning\\_education](http://www.ericsson.com/thinkingahead/networked_society/learning_education)) but the actual implementation is quite another matter.

There are so many great programs addressing the problem though. I recently visited a Hackerspace known as FUBAR Labs – (Fair Use Building and Research) at Rutgers University, Livingston campus location.

Rick Anderson has been bringing together technologies, like a 3-D printer, with engineering students who wanted to get their hands on these technologies. I will go back soon to learn more about the program and possibly to help out.

Many engineering majors have never actually built a circuit on a breadboard or designed, etched, drilled, stuffed and soldered a PC board. I will continue to introduce students to these hands-on methods wherever I can, and I would appreciate your comments and suggestions for helping technology seekers and for other programs worth working with.

# Your question: What's wrong with my USB device?

**Our answer: Find out with our USB 2.0 compliance test solution.**

Verify output signal quality and input sensitivity:

The new USB 2.0 compliance test software from Rohde & Schwarz performs these tests and more. It controls the RTO high performance oscilloscope and guides the user through the test sequence, an easy and straightforward process thanks to the intuitive operating concept. Test results are documented in a comprehensive report. To make sure your product achieves USB 2.0 certification.

**Convince yourself.**

[www.scope-of-the-art.com/ad/faq-usb](http://www.scope-of-the-art.com/ad/faq-usb)

**Warranty program  
available until June 2013:**

Register your new scope and get a  
five year warranty instead of three!  
[www.scope-of-the-art.com/ad/warranty](http://www.scope-of-the-art.com/ad/warranty).



# BMW brings LTE connectivity to its vehicles and others

By Christoph Hammerschmidt

**CARMAKER BMW IS OFFERING** an LTE access device as an optional accessory part for his vehicles. The device acts as a router for up to eight mobile devices simultaneously, bringing high-speed and low-latency mobile internet access to the road.

Apart from the BMW Car Hotspot LTE an LTE-capable SIM card is required. The first time a mobile device is connected to the BMW Car Hotspot LTE using the mobile device's WLAN interface, an eight-digit code must be entered. This is a one-off requirement. If the mobile device is equipped with an NFC interface, the WLAN connection is automatically established simply by briefly placing the NFC-capable device on top of the LTE Hotspot. According to BMW, this is the first time NFC functionality has been offered in the car. "Plug and play" is something of an overworked term, but this is the genuine article," says Markus Dietz, Project Manager BMW Car Hotspot LTE Development.

If the customer's device is not NFC-capable, the BMW Car Hotspot LTE also offers WPS (WiFi Protect Setup) as a solution for establishing a WLAN connection. Using this method it is possible to establish a secure connection between the hotspot

and a mobile device situated within a range of three metres simply by pressing the hotspot's "connect" button once and without entering a PIN.

The accessory piece is designed for optimal operation in any vehicle of the BMW Group equipped with a telephone docking station. The docking station provides the power supply and ensures optimal reception. When placed in the BMW docking



station, the BMW Car Hotspot LTE connects to the internet using the vehicle aerial. This means that reception cannot be impaired for example by tinted windows, while also preventing radiation inside the vehicle. But it is also possible to use the hotspot even without a docking station. In this case, using an optionally available adapter and mini-USB cable, the power is provided by plugging the BMW Car Hotspot LTE into the cigarette lighter. Thus, the hotspot can be used in any vehicle.

Equipped with a built-in battery pack, the BMW Car Hotspot LTE can even be used outside the vehicle. Away from an external power supply the hotspot can provide internet access for about an hour.

# Volvo, Ericsson jointly connect cars to the cloud

By Christoph Hammerschmidt

**WITH LTE IN THE STARTING BLOCKS** and the Connected Car increasingly taking shape, new alliances are in the offing. Volvo Car Group and Ericsson now have announced that they plan to jointly advance the technical development of innovations for automotive internet services. To the joint efforts, Volvo will bring in its expertise in driver behavior and traffic security requirements while Ericsson will contribute its consulting and systems integration.

Both companies plan to conjointly build the ecosystem around the connected car. The solution covers all Volvo Cars markets around the globe and is run as a Managed Service by Ericsson.

Drivers will be able to download applications, create an online service booking and interact with partners through the Connected Vehicle Cloud built on Ericsson's Service Enablement Platform. The partnership is focused on the rapid development



of Volvo Cars' stand-alone scalable product architecture (SPA). However, connected car services will roll out in all new Volvo cars beforehand in order to position Volvo Cars with sophisticated solutions and services.



DESIGNSPARK

# NEW POWERFUL RESOURCES FOR FASTER DESIGNS

## **NEW. FREE.** DESIGNSPARK PCB VERSION 4

COMPREHENSIVE NEW LIBRARIES.  
EASIER COMPONENT SELECTION & QUOTATION.  
NEW PCB PROTOTYPING SUPPORT.

## **NEW. FREE.** MODELSOURCE

OVER 80,000 FREE SCHEMATIC AND PCB SYMBOLS  
IN MORE THAN 20 FORMATS, INCLUDING PADS,  
ORCAD, ALTIUM AND CADSTAR.

Discover today at  
[www.designspark.com](http://www.designspark.com)

UNIQUE  
RESOURCES BY 

## London Calling: A northern light startup

By Peter Clarke

**SOLID-STATE LIGHTING** is one of my tips for a technology-driven trend in 2013 and no sooner has the year begun than I receive the news that VTT Ventures Ltd. (Espoo, Finland) and Lumichip Oy (Espoo, Finland) have invested in a startup company called LightTherm Ltd. (Oulu, Finland). The far north has the aurora borealis and, in the winter, a great need for lighting. So it should perhaps be no surprise that a Finnish cluster of expertise is developing around the topic of lighting.

LightTherm claims to have a patent-pending proprietary LED die interconnect technology that it reckons can produce cooler semiconductor junction temperatures. The capacity of its technology to produce improved thermal efficiency and management is expected to have a beneficial impact on the lifetime of LEDs for lighting applications. The company aims to combine lower operating temperatures with new materials to produce reduced materials, simpler and automated manufacturing and lower-cost LED light bulbs.

VTT Technical Research Center is a government backed applied research institute and VTT Ventures is chartered with helping to create spin-off companies to exploit the research. Lumichip makes LED chips and packaged light engines and has operations in Finland, Hong Kong and Taiwan. LightTherm's technologies are based on development, characterization and

lifetime tests carried out at VTT.

LightTherm's founding team consists of Petri Nyman, Ville Moilanen and Kimmo Jokelainen. CEO and co-founder Nyman has experience with startups as well as in the management of growth companies. Co-founders Moilanen and Jokelainen have a research background with VTT and developed the core innovations behind the technology.

The investors have decided not to disclose the size of the investment they are making in LightTherm at this time. But if the company wants to catch the LED lighting wave it should probably move as quickly as it can. It is forecast that a billion LED light bulbs will be produced in 2013 making an annual market worth about \$20 billion. LED technology still faces some challenges, particularly where high light output is required from small compact light units. Many of the components and materials used in manufacture are heat sensitive and overheating can shorten the lifespan.

"LightTherm materials, device construction and manufacturing processes give flexibility in design, and will enable the manufacture of entirely new lighting applications for both consumer and industrial luminaires. We believe this will change completely the way in which LED products are manufactured in the future," said Juha Rantala, chairman of Lumichip, in a statement.

## Supercapacitors enter the realm of stretchable electronics

By Julien Happich

According to the University of Delaware's Bingqing Wei, stretchable electronics are the future of mobile electronics, leading giants such as IBM, Sony and Nokia to incorporate the technology into their products.

"Advances in soft and stretchable substrates and elastomeric materials have given rise to an entirely new field," says Wei, a mechanical engineering professor at UD. But even if scientists can engineer stretchable electronics - what about their energy source? "Rechargeable and stretchable energy storage devices, also known as supercapacitors are urgently needed to complement advances currently being made in flexible electronics," explains Wei.

Wei's research group at the University is making significant progress in developing scalable, stretchable power sources for this type of application using carbon nanotube macrofilms, polyurethane membranes and organic electrolytes. This, he says, requires new thinking about materials processing and device manufacturing to maximize energy storage without compromising energy resources. To reveal a stretchable supercapacitor's true performance, the Wei group examined the system's electrochemical behavior using buckled single-wall nanotube (SWNT) electrodes and an elastomeric separator.

According to Wei, the supercapacitor developed in his lab achieved excellent stability in testing and the results will

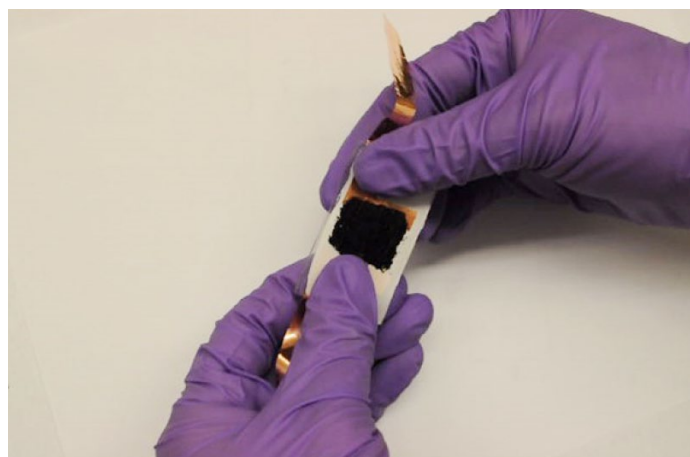

A stretchable supercapacitor made of carbon nanotube macrofilms, polyurethane membranes and organic electrolytes. Source: University of Delaware at [www.udel.edu](http://www.udel.edu)

provide important guidelines for future design and testing of this leading-edge energy storage device. As they work to refine the technology, Wei has filed a provisional patent to protect his team's research. The work was recently published in *Nano Letters*, a journal of the American Chemical Society.



**FREE SHIPPING**  
ON ORDERS OVER €65!



# THE WORLD'S LARGEST SELECTION OF ELECTRONIC COMPONENTS AVAILABLE FOR IMMEDIATE SHIPMENT!



**74,322 m<sup>2</sup>**  
FACILITY

**2,500+** EMPLOYEES

**OVER 660,000**  
PRODUCTS  
IN STOCK

**2.5 Million**  
PRODUCTS  
ONLINE

**CUSTOMER SERVICE**



**TECHNICAL SUPPORT**

**PROTOTYPE to PRODUCTION<sup>®</sup>**

High-Mix / Low-Volume Production  
Transferred Inventory Risk  
Supply Chain Management

**600+**  
SUPPLIER  
PARTNERS

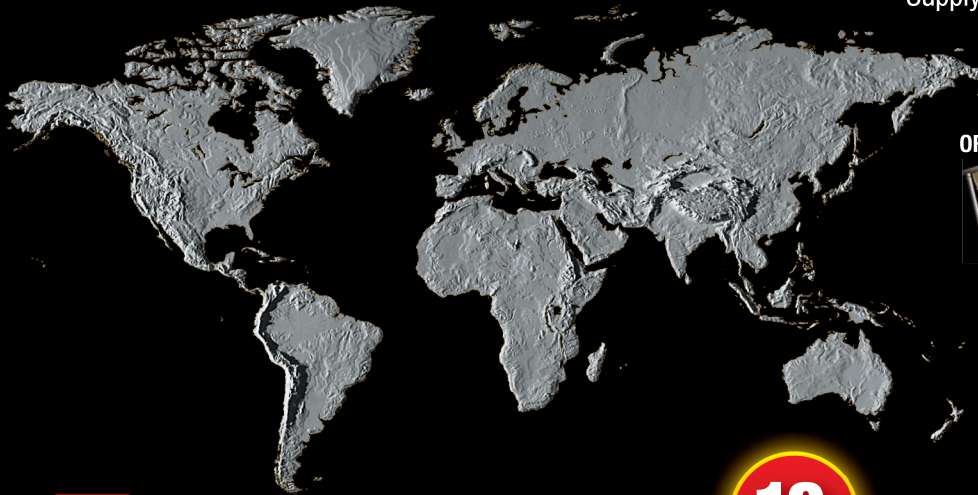

ORDER ENTRY  
TO SHIPPING  
**20**  
MINUTES  
OR LESS

**100%**  
AUTHORIZED  
Distributor

**10**  
LANGUAGES

**15**  
CURRENCIES

**48%**

**'BEST OF CLASS'  
FOR BROADEST  
OVERALL PRODUCT  
SELECTION?**

Source: 2012 Design Engineer and Supplier Interface Study, Hearst Business Media, Electronics Group, North America, May 2012

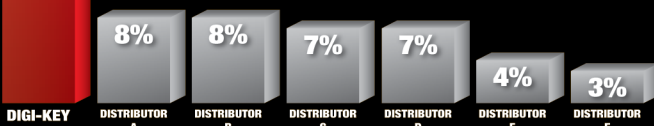

FIND CONTACT AND ORDERING  
INFORMATION FOR YOUR REGION AT

**DIGIKEY.COM/EUROPE**

\*A shipping charge of €18.00 (£12.00) will be billed on all orders of less than €65.00 (£50.00). All orders are shipped via UPS for delivery within 1-3 days (dependent on final destination). No handling fees. All prices are in euro and British pound sterling. If excessive weight or unique circumstances require deviation from this charge, customers will be contacted prior to shipping order. Digi-Key is an authorized distributor for all supplier partners. New product added daily. © 2013 Digi-Key Corporation, 701 Brooks Ave. South, Thief River Falls, MN 56701, USA

# Seeing the light

By Nick Flaherty

**A FOCUS ON SENSORS FOR HEALTH** equipment and high brightness LEDs may seem two very different markets, but the chief executive of Plessey Semiconductors sees them as key opportunities for the growth of the company over the next few years.

The key says Mike LeGoff is that Plessey is not a commodity company, even though it is entering into several commodity markets, including the consumer market. Instead it is a sensor company that understands the links between electronics and human physiology, whether that's sensing the body or the performance of the human eye.

This is a long way from its recent past when it was an analogue component maker with a fab in Plymouth in the South-West of the UK and design in Swindon. "We bought Plessey three years ago in May 2009 and the whole process took six to nine months," said Le Goff. "It's been absolutely brutal, the 2008 assets were cheap so we were able to bootstrap the business but to really grow and expand we had to choose what we wanted to do, and that is health and fitness, energy and LEDs."

As a result the Plessey from three years ago has gone completely, he says. "We had a legacy analogue tuner business for set top boxes and we did a lot of CMOS imagers for space and defence as well as for dental imaging. That has all changed," he said.

One area that is still interesting is using the sensors for genome sequencing, which ties into the health applications. The sensors are used to take the image of the separated DNA and much to LeGoff's delight are thrown away after each sample. "That's good business," he said. "The best use is for plant and vegetable DNA. A good example is the recent e.coli outbreak to track down where the outbreak came from."

But it is the EPIC sensor for health applications that is the initial growth engine for the company. "The explosive growth will come on the back of EPIC and on the back of that will be the high brightness LED," he said.

The move into LEDs follows the acquisition of University of Cambridge spin out CamGaN in February, which had been partnering with Plessey for several years. "We have been working with the Cambridge group for four to five years and we have a reactor in Plymouth for lateral LEDs," he said.



Plessey plans to launch its own health monitor called impulse as part of its new strategy.



"We want to get off the commodity curve" says Plessey's CEO Mike Legoff.

Because we are looking at specialist applications for things like accent lighting eventually to high brightness for lighting LEDs by the end of 2013, we'll be sampling from May."

He believes this puts Plessey in an elite group of companies.

"There are huge competitors. At the moment even the Chinese can only do LED on 2-inch sapphire wafers and that's very expensive," said LeGoff. "You have BridgeLux and Toshiba on 8-inch wafers, Samsung on 8-inch, Osram on 6-inch and Plessey on 6-inch. This will lower the cost 10 fold from \$2 to 20c."

This is entirely consistent with the strategy, he says. "We understand electronics and the manufacture and performance of sensing technology. We are not an IC company we are a sensing company. We have a growing strength in how we as human beings interact with electronics through touch, through fields, through reactions to light. That's the problem in the marketplace that companies from automotive to Apple are trying to solve. We want to gain a better understanding of all the physiological changes, things like lighting with LEDs."

He is very aware of the risks of the strategy. Competing with large suppliers such as Samsung and Toshiba could see Plessey becoming a commodity supplier of LED die for a few cents and vulnerable to the larger companies with larger economies of scale.

"We want to get off the commodity curve," he said. One of the ways to do that is partnering, both in China and with the potential competition such as Samsung." We are a solutions provider – we don't do commodity. We go into a smartphone manufacturer with human body models, interfaces and licensing options as well as the electrodes and the chip. We need to work closely with customers."

The global partnerships and markets are vital. "We have very strong partners in China. We sold a lot of the equipment in

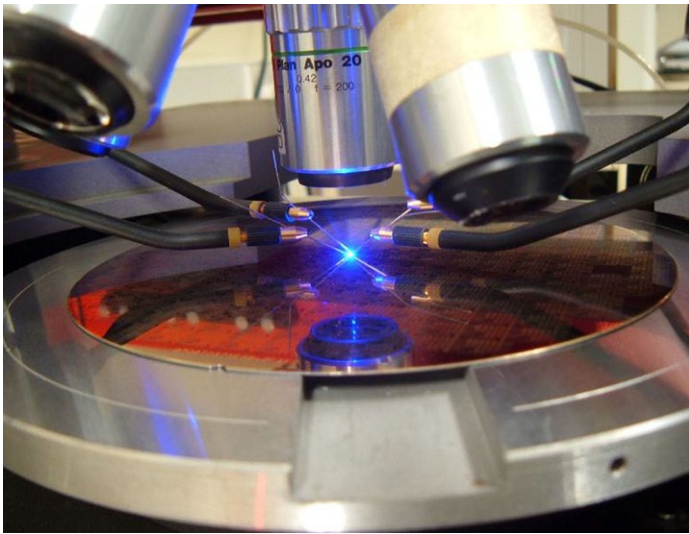

Plessey's high brightness GaN LEDs on a silicon substrate.

Swindon to China and we have good relationships with an LED consortium in China," said LeGoff. "They don't have the technology in certain areas but have a good manufacturing base. They also have a lot of money that they are willing to spend.

"The US is still the biggest economy in the world and Japan is still the third largest. Korea is a baby China – we are selling a lot of product into Samsung because they acquired some of our customers. They want to be big in medical equipment to compete with GE, Philips and Siemens.

But he does acknowledge the new strategy is taking time. "We are not scalable yet. With the EPIC sensor it takes time. We are in a gaming platform that we want to see released but it's going to happen," he said.

"We are sampling now but just to start live testing. Real production will be in Q1 of 2013. These two will drive us to £100 to £200m revenue. The critical part is to really define what it is we do for our customers. We have a good handle on the electronic side and that's what we can provide different."

Having control of the fab also gives us a quicker turn-around and more flexibility. "We can produce 100 million dies per week from a couple of reactors at 20 to 30 cents each, but then the challenge is how you turn this into smart lighting. If you are fabless you have to think about multi-project wafers. If you own your own fab you can get a complete design re-spin in a month and the cost is tens of thousands of dollars rather than hundreds of thousands. But the strategy also includes the move into the consumer market under the Plessey brand, both for the health products using EPIC but also for the high brightness LEDs. Earlier this year Plessey launched a reference design for a pulse monitor using EPIC and the electrodes that will turn into a branded product.

"We have done a reference design and people love it and wanted to buy it. The Plessey name has that brand acceptance and I believe we can do that, but it's such a massive step. For the end of 2014 should Plessey have a few products? Home health, smart lighting module in your local DIY store, let's try it. Maybe the B2C model is something we can move into gradually.

How does that fit with the investors that have backed Plessey so far? "Investors will come and go as they please, the brand is strong enough" he said. "If we get some traction we would like to believe that we can be part of the resurgence of electronics design and manufacture in the UK. There's a lot of government support out there. We need to get back to building products over the next five to ten years."



mouser.com

The Newest Products for Your Newest Designs®

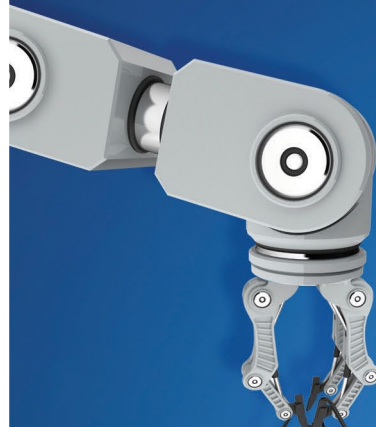

The Next Big Thing Is Here.

**NEWEST**  
**PRODUCTS**



*The NEWLY redesigned  
Product Knowledge Center.*

**More** Product Knowledge  
**More** New Products  
**More** Technologies



**MOUSER**  
ELECTRONICS

Authorized distributor of semiconductors  
and electronic components for design engineers.

# Silicon-based optical fiber with solar-cell capabilities could be woven into solar fabrics

By Julien Happich

**AN INTERNATIONAL TEAM** of chemists, physicists and engineers, led by John Badding, a professor of chemistry at Penn State University, has demonstrated for the first time, a silicon-based optical fiber with solar-cell capabilities that is scalable to many meters in length. The research opens the door to the possibility of weaving together solar-cell silicon wires to create flexible, curved or twisted solar fabrics.

The team's new findings build on earlier work addressing the challenge of merging optical fibers with electronic chips, silicon-based integrated circuits that serve as the building blocks for most semiconductor electronic devices such as solar cells, computers and cellphones. Rather than merge a flat chip with a round optical fiber, the team found a way to build a new kind of optical fiber, with its own integrated electronic component, thereby bypassing the need to integrate fiber-optics with chips. To do this, they used high-pressure chemistry techniques to deposit semiconducting materials directly, layer by layer, into tiny holes in optical fibers.

Now, in their new research, the team members have used the same high-pressure chemistry techniques to make a fiber out of crystalline silicon semiconductor materials that can function as a solar cell, a photovoltaic device that can generate electrical power by converting solar radiation into direct-current electricity. "Our goal is to extend high-performance electronic and solar-cell function to longer lengths and to more flexible forms. We already have made

meters-long fibers but, in principle, our team's new method could be used to create bendable silicon solar-cell fibers of over 10 meters in length," Badding said. "Long, fiber-based solar cells give us the potential to do something we couldn't really do before: We can take the silicon fibers and weave them together into a fabric with a wide range of applications such as power generation, battery charging, chemical sensing and biomedical devices."

Woven, fiber-based solar cells would be lightweight, flexible configurations that are portable, foldable and even wearable." This material could then be connected to electronic devices to power them and charge their batteries. "The military especially is interested in designing wearable power sources for soldiers in the field," Badding added.

The team members believe that another advantage of flexibility in solar-cell materials is the possibility of collecting light energy at various angles. "A typical solar cell has only one flat surface," Badding said. "But a flexible, curved solar-cell fabric would not be as dependent upon where the light is coming from or where the sun is in the horizon and the time of day."

Pier J. A. Sazio of the University of Southampton in the United Kingdom and one of the team's leaders added, "Another intriguing property of these silicon-fiber devices is that as they are so compact, they can have a very fast response to visible laser light. In fact, we fabricated fiber-based photodetectors with a bandwidth of over 1.8 GHz."

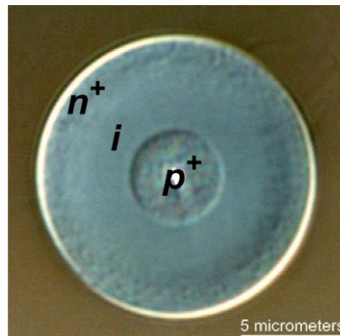

A cross-sectional image of the new silicon-based optical fiber. Shown are layers, labeled  $n^+$ ,  $i$  and  $p^+$ , that have been deposited inside the pore of the fiber: Source - Penn State University

# Energy-harvesting textile integrates micro spherical solar cells

By Julien Happich

**IN COOPERATION WITH** the Industrial Technology Center of Fukui Prefecture, Japan, Sphelar Power Corporation has successfully prototyped an energy-harvesting textile where spherical solar cells are interwoven.

This result was delivered from an interdisciplinary collaboration between Sphelar Power, which uniquely developed 3-dimensional light capturing Sphelar cells, and the Industrial Technology Center of Fukui Prefecture which serves as innovative R&D hub for local textile industries. First, 1.2mm Sphelar cells are aligned and connected as a thread which is then woven

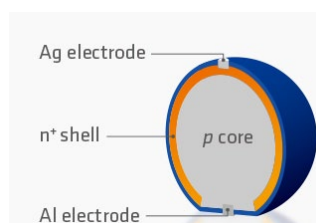

as an energy-generating mat.

The photovoltaic modules obtained can be not only flexible, but also expandable just like textile. One of the benefits of the Sphelar cell is that it can receive sunlight more effectively and more uniformly than conventional flat solar cells. Hence the solar cells are less dependent on the angle of incoming light. Each spherical solar cell designed as a multi-layered bead features two electrodes on opposite sides.

This structure enables 3-dimensional light capture and extends the device's application range, from horizontal installations to integration into curved surfaces and 3-dimensional solar modules.



energy generating thread with Sphelar® cells (drawing)



**No other oscilloscope can touch it.  
But you can.**



**The oscilloscope experience redefined.**

Agilent's next-generation oscilloscopes offer waveform update rates 20 times faster than the competition. With the latest capacitive touchscreen technology and innovative InfiniiScan Zone touch triggering, you haven't really experienced an oscilloscope until now.

**Agilent InfiniiVision  
4000 X-Series Oscilloscopes**

200 MHz to 1.5 GHz

12.1-inch screen designed for touch

InfiniiScan Zone touch triggering

1M waveforms/sec update rate

Fully upgradable: bandwidth, MSO,  
dual-channel WaveGen, DVM,  
serial analysis including USB



Scan or visit  
<http://qrs.ly/8o264ck>  
to see a video demo

**Agilent and our  
Distributor Network**  
Right Instrument.  
Right Expertise.  
Delivered Right Now.

**Buy from an  
Authorised Distributor**  
[www.agilent.com/find/distributors](http://www.agilent.com/find/distributors)

**Experience the difference.  
See demos, app notes and more.**  
[www.agilent.com/find/4000Xexperience](http://www.agilent.com/find/4000Xexperience)



## Lighting out of the printer

By Christoph Hammerschmidt

**AS OLEDs ARE** approaching industry maturity, lighting company Osram announced that it is already conducting research for another innovation that has the potential to change the world of lighting: Light emitting fibres produced in a printing process. In the long run, this process could enable to manufacture large-area luminaires at very low prices.

The fibres are based on light-emitting electrochemical cells made of organic materials, so-called OLECs (Organic Light-emitting electrochemical cells). Closely related to OLEDs, they however do not incorporate a solid material but a viscous one.

This active viscous layer assumes the task of conducting electric current as well as emitting the light. In the liquid phase, this material contains freely mobile ions. As soon as a voltage is applied, they accumulate at the edge. Only then, electric charges can be injected into the light emitting layer, effectively creating a light emitting diode. By combining various materials appropriately, the cells basically can emit light in any desired color.

In a pilot production line in Augsburg, Osram researchers led by Dr. Frank Vollkommer were able to create functioning lighting cells at a size of 14 x 15 centimeters. They used a plastic foil as substrate with a conductive transparent layer on it. On top, they applied another conductive polymer layer by means of a precision slotted nozzle. After an infrared drying step, the light-emitting layer has been applied by means of the same method.

Finally, standard metal electrodes have been vapour deposited. "In contrast to LED and OLED production, this process does

not require cleanrooms", Vollkommer said. Only the machine itself needs to be kept clean of particles which can be achieved through constantly supplying clean air.

The research has been conducted within the European research project CELLO. Besides Osram, also Siemens and five research institutes participated in the project. So far the



researchers were able to achieve LECs with an efficiency of 17 lumens per watt in the green part of the light spectrum - as a comparison an incandescent light bulb achieves an efficiency of some 10 lm/w.

The next goals for the project are now higher efficiency and longer operating life. Another challenge is the homogeneity of the light emission, Vollkommer said.

## Toshiba starts GaN-on-Si LED production

By Peter Clarke

**TOSHIBA HAS ANNOUNCED** that it will start production of white light emitting diodes intended for use by makers of general purpose and industrial lighting using Bridgelux technology.

The white LEDs are made using gallium nitride grown on 200-mm diameter wafers of silicon. Toshiba said it plans to ramp capacity up to 10 million LEDs per month and said it wants to secure a 10 percent market share by 2016.

Production of LED chips is typically done on 2- to 4-inch sapphire wafers. Bridgelux Inc. (Livermore, Calif.) developed a method of manufacturing gallium nitride LEDs on 200-mm

silicon wafers, which provides a cost advantage. With backing for Bridgelux from Toshiba, that process was brought to Kaga Toshiba Electronics Corporation, a discrete products manufacturing facility in northern Japan. Plessey Semiconductors Ltd. (Plymouth, England) has also adopted a GaN-on-Si process for LED production but is presently ramping with 6-inch diameter wafers.

The first product of the Toshiba GaN-on-Si line is the TL1F1 series of LEDs that produce 112 lumens at 350-milliamps current. The packaged parts measure 6.4-mm by 5.0-mm by 1.35-mm.

# Troubleshooting and verifying 8b/10b encoded signals with a real-time oscilloscope

By Dean Miles

**FEW SERIAL TECHNOLOGIES** have become more widely adopted than 8b/10b coding, which is now used in standards like PCI-Express, Serial ATA, SAS, Fibre Channel, InfiniBand, FireWire, MIPI M-PHY, HDMI, DisplayPort, CIPRI, OBSAI, XAUI, USB3.0 and others. Therefore, any designer will eventually need the ability to efficiently analyze 8b/10b encoded signals using common instrumentation such as a real-time oscilloscope.

The intent of 8b/10b line coding is to achieve DC balance and provide enough state changes to ensure stable clock recovery. Since DC balance is maintained, 8b/10b signals can be transmitted through transformers, optical channels or AC coupled links which have DC offsets at the pins of their integrated circuits. AC coupled data signals would have DC drifts depending on the data content. A long sequence of 1s will lead into positive drift and many 0s will drift toward negative voltage, as shown in figure 1. Without correction it will cause errors at the receiver side since a fixed threshold is being compared to the drifting voltage level of the data signal.

8b/10b line coding will compensate for these effects by mapping 8 bits of data to 10 bit symbols (or characters). Each 8 bit word corresponds to two 10b characters to ensure the long term ratio between 1's and 0's is nearly 50 percent, as outlined in figure 2. The difference in numbers between 1s and 0s is called "running disparity" (RD) and it is either +1 or -1. Therefore the encoding of one 8 bit data word will change depending on the preceding symbol at the speed of the data rate.

With high-speed serial signals now delivering multiple gigabits per second, they require very high bandwidth in the physical layer for their links. One way to verify the performance of serial links is compliance testing. Usually compliance tests are used for characterization at a final state of the design. If the compliance test passes everything is fine. If not, debugging of the physical layer might become necessary.

A first step is often to look for measurements that are out of range related to the appropriate standard's specifications.

This can indicate where to perform further measurements and suggest actions to solve the problem. If this does not solve the problem, the engineer can look at a composite of all data values and transitions on the bus using an eye diagram.

The eye diagram can show issues related to noise, jitter, and signal integrity. It can also be used to check for violations of an eye diagram mask which are specified in many industry standard compliance tests. Any kind of degradation of the signal will cause less margin or more hits in the eye mask. This degradation can indicate significant problems in the physical layer

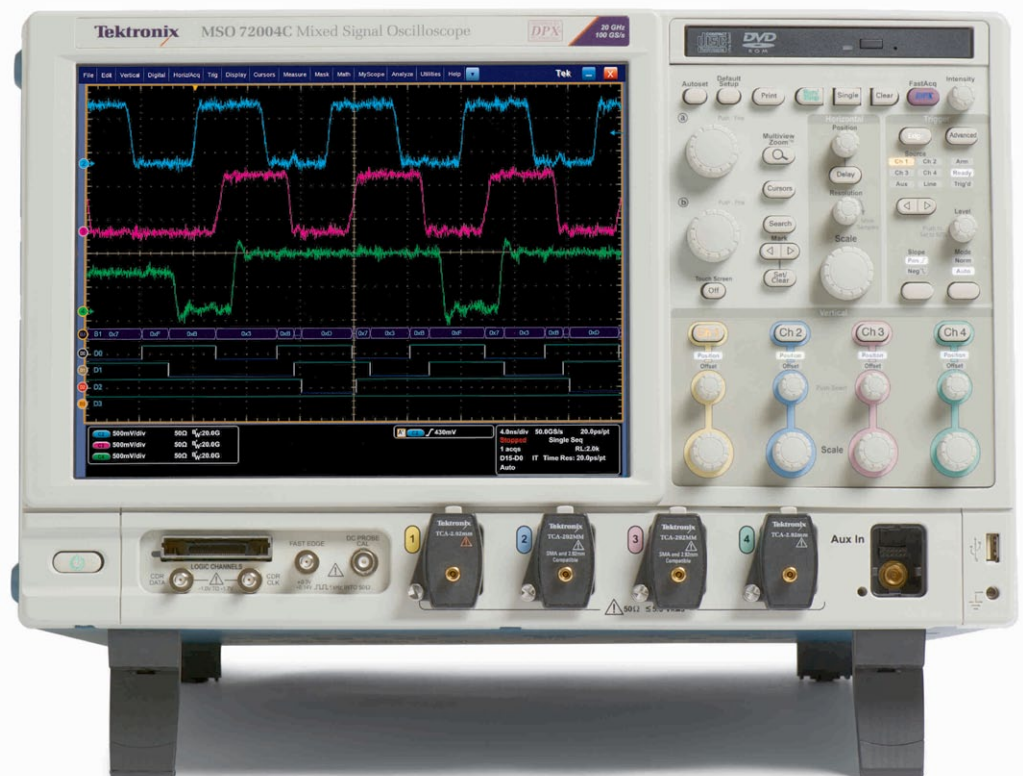

(PHY) design. Examples of signal integrity issues that can lead to mask test failures include slow signal rise time (bandwidth), small signal amplitude (attenuation), large overshoot (inductance), or large jitter and noise components such as cross talk and intersymbol interference (ISI).

## Debugging protocol errors

Issues with the PHY layer will often cause intermittent faults. Usually PHY verification and protocol testing are done with different test equipment and under different conditions using an oscilloscope.

To ensure best signal fidelity and highest timing resolution, the engineer should evaluate the link at the compliance test point with an oscilloscope and convert the acquired "analog" waveform into binary values or even characters and com-

Dean Miles is a Senior Technical Marketing Manager at Tektronix - [www.tek.com](http://www.tek.com)

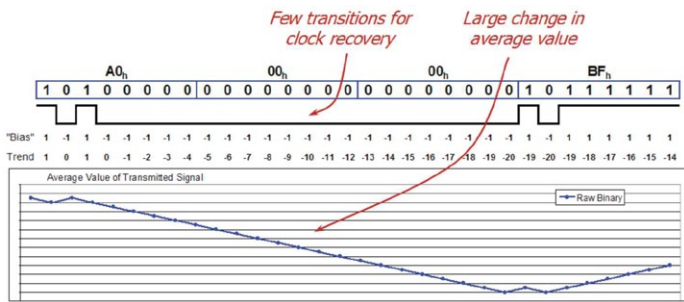

Fig. 1: DC drifts without 8b/10b encoding.

mands. The protocol trigger and decode software can be used to convert the waveform data into a binary format by recovering the clock first and comparing the voltages with a user-defined threshold and some hysteresis. A block diagram of how this software works is shown in figure 3, with results shown in figure 4.

As shown, there are two tables that list the characters and the protocol. The protocol is correlated to characters and to 0s and 1s in the acquired waveform. This makes it easy to track errors in the protocol down to the physical layer. The displayed waveform in figure 5 can be useful to understand why wrong 0s and 1s have been possibly misinterpreted by the receiver. Cursors and the actual zoom window can be synchronized with the scope waveform display and can help in locating the cause of the protocol error.

### Capturing specific data values

Searching for a specific character in the protocol table is a common method to locate protocol errors in the data stream. But searching is a post-acquisition process and is limited to a time frame that is set by the size of the acquisition memory. The dead time between acquisitions is quite large and is caused by oscilloscope and the processing time of the software for interpreting the waveform into binary and then searching for the character. This is illustrated in figure 6.

Therefore the chance of capturing any infrequent and rare faults is very low. For example if there are 10 million points sampled at 50 GS/s, the real time acquisition will stop after 200 microseconds. But it will take hundreds of milliseconds before the system can capture the next block of 10 million points. Larger memory will even increase the problem. To find rare events it is necessary to trigger on those faults.

Most digital oscilloscopes provide a large portfolio of triggering capabilities. Traditionally, troubleshooting is related to time and level qualified triggering. With the advanced trigger modes available, triggering on glitches, transitions, runts and so forth is much easier than in the past. For protocol errors, it can be useful to trigger on commands, characters, or bit sequences. Unfortunately a serial trigger circuit designed for NRZ patterns cannot find those faults because most high speed serial data signals are 8b/10b coded and require a dedicated hardware solution. A standard NRZ trigger cannot trigger on words of 8b/10b coded data streams for two reasons.

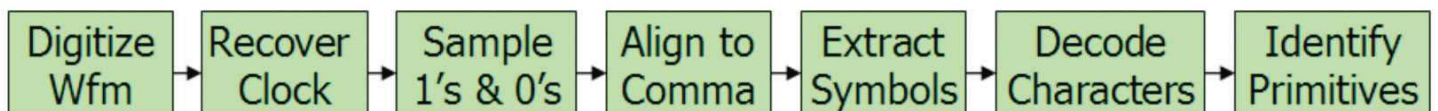

Fig. 3: Conversion of waveform data into protocol.

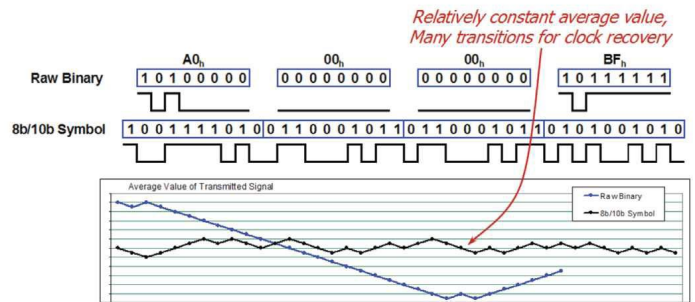

Fig. 2: 8b/10b coding maintains DC level and ensures clock recovery.

First, the coding of the 8 bit word to 10b symbol will change at the speed of the data rate and would require an adjustment of the symbol rate in the trigger memory to the same speed. Second, triggering on the right 8b/10b symbol requires synchronization or alignment of the 8b/10b codes to the data stream. For real time triggering the hardware must be capable to synchronize to one of the “comma symbols” (K.28.1, K.28.5, and K.28.7) which are unique and cannot be found in the data stream at any bit position in the code. The synchronization character can be somewhere in the data stream and might be very infrequent or appear only once. One example for a synchronization character is the comma symbol, K28.5 (011110101). Once the alignment symbol has been found, the decoding of the subsequent symbol values can proceed.

Software “triggering” solutions actually perform a search through the acquired data and therefore have long dead times that cause very large gaps between the acquisitions and increase the chances of missing the character in question.

Many higher end oscilloscopes are equipped with a dedicated trigger chip for triggering on 8b/10b data patterns in high speed serial signals up to 6.25 Gb/s. This enables the instrument to find rare events since it is now able to trigger on 8b/10b characters. Characters are acronyms for a pattern of 10 bits of the 8b/10b code, i.e. D31.6 or K28.5. A second option related to a high speed serial standard’s protocol is triggering on 8b/10b words (commands), where words consist of multiple characters (commonly 4 words or 40 bits). It should be noted that every standard has its own word definitions.

A powerful debugging tool is the ability to trigger on 8b/10b code errors. No serial trigger would be able to trigger on all possible character errors, disparity errors or losses of byte synchronization, but it is usually possible to trigger on common errors such as disparity or character errors.

### Network element delay measurements

Triggering on 8b/10b serial patterns can be used for measuring the time delay of an active network element. One might think this an easy task to solve even without special triggering on 8b/10b. But it can be challenging when it’s necessary to measure the time delay under real conditions. The setup for this measurement is shown in figure 7. The input signal of the



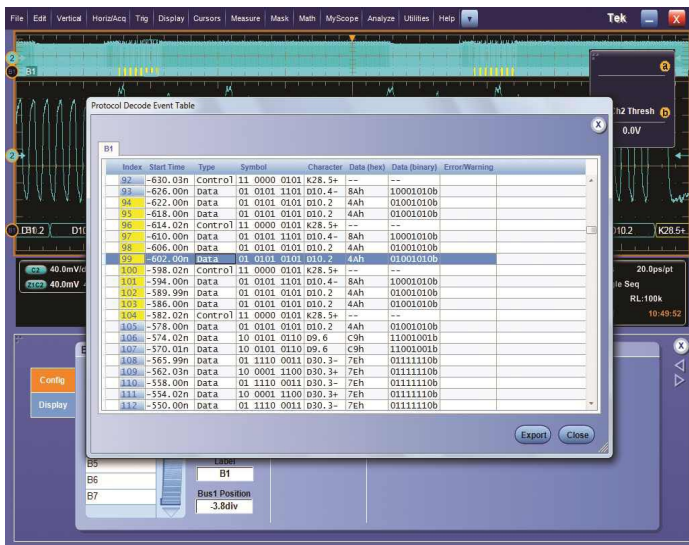

Fig. 4: Protocol view of characters, protocol and waveform.

network element is connected to Channel 1 and the output data stream is connected to channel 2 of the oscilloscope. A data generator will provide the required data stream to the input of the network element (DUT). A unique pattern inside the data stream will perform as a timing reference. This timing reference needs to be a very rare pattern to prevent confusion with another timing position. If the pattern has been defined you can search for that pattern in the acquired signal of channel 1 and channel 2 and then measure the time between the two locations.

A software decoding function could help to find the sequence in the data stream. Because of its infrequent occurrence the search for the pattern can be very difficult. Given oscilloscope acquisition memory limitations, the chance of finding the pattern for the timing reference is low. Unlike searching, 8b/10b triggering makes it much to find the sequence. This is because triggering ensures that the pattern will always be inside of the acquisition window.

Without 8b/10b triggering the delay measurement would require a trigger signal from the data generator to the oscilloscope. That would be the only way to synchronize the starting point of the 8b/10b timing reference at the output of the data generator with the acquisition window of the oscilloscope. However, this method fails to replicate real world conditions.

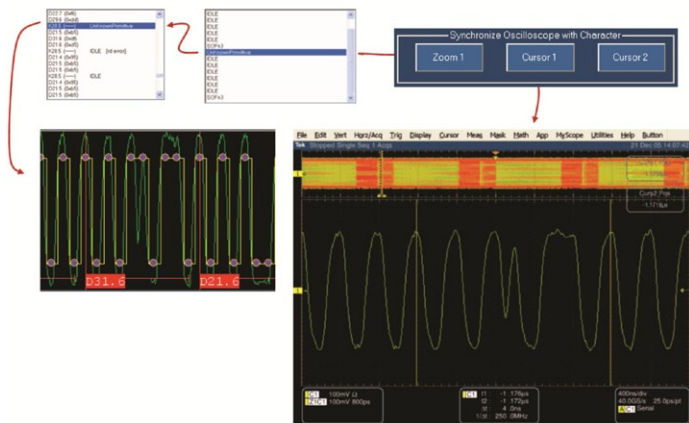
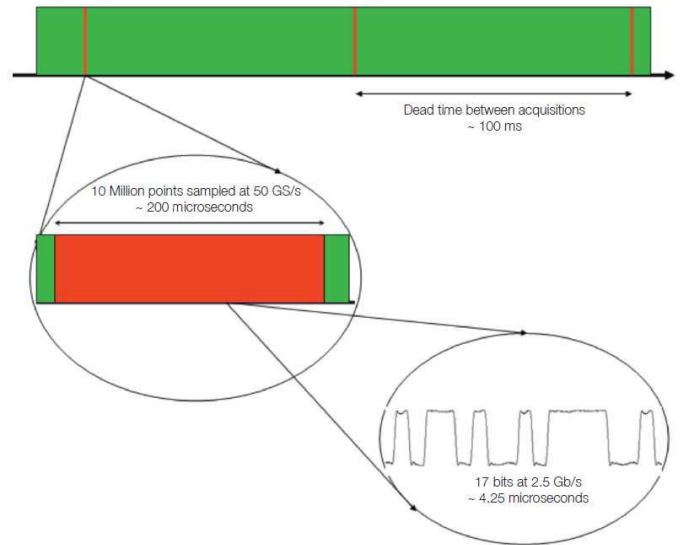

Fig. 5: Tracking a protocol failure to a glitch in the waveform.



## 6: Dead time between acquisitions.

In the set up shown in figure 7, a bidirectional link connects the two network elements. Network element A acts as a data source to ensure that network element B (DUT) works in a desired operating mode. The communication link has to be established by proprietary commands and the data flow of this commands needs to be maintained during the measurements to keep the DUT in the desired operation mode. Therefore a static data pattern provided by any data generator will not work.

Similar to the previous example a unique pattern is required for a timing reference (marker) in the data stream. Since the pattern is very infrequent and there is no trigger signal available from the source network element A, an 8b/10b trigger is required to find the pattern in the input and the output signal of the DUT.

The optimum way to see and measure the delay between the input and output of the network element is to use two zoom windows. The first zoom window is placed at the beginning of the pattern sequence at channel 1 and the second zoom window at the beginning of the pattern sequence at channel 2. For the delay measurement the acquisition time window of the oscilloscope should be equal to or greater than the delay time.

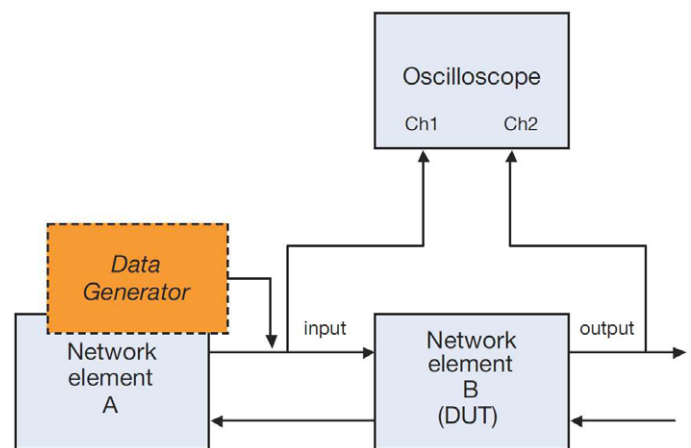

Fig. 7: Time delay measurement setup.

## Near field analysis for EMI/EMC

By Deepak Kumar Behera, Sumit Varshney, Sunaina Srivastava and Swapnil Tiwari

**EMI/EMC CHARACTERIZATION** is essential for many electronics products. The high speed signals may induce not only signal integrity and power integrity issues, but also cause radiation and electromagnetic interference problem. For low frequency signals (up to 100MHz) radiated and conducted emission can be ignored but as wavelength becomes comparable to the trace length circuit approximation is no longer valid. The trace geometry and its separation become important in case of PCB. The signal's rise time, fall time, period and pulse width play the role in determining the EMC of PCB's. A lack of knowledge of fundamental EMI sources also makes anticipating potential EMI problems at the design stage troublesome. The designer should take care of EMI sources so that the product complies with FCC limits.

### Conducted & radiated emissions

The two most common EMI types are conducted and radiated. Conducted emissions are the radio frequency noise present in the physical wiring and traces of any electronic system. This results in unwanted common mode and differential mode currents within a system. The frequency range where conducted emissions are regulated is typically lower than the frequency range where radiated emissions are regulated. The longer wavelength where conducted emissions are a problem needs a much larger antenna to radiate and receive electromagnetic interference than the shorter wavelengths studied for radiated emissions. Conducted emissions are regulated by the FCC over the frequency range 450 kHz to 30 MHz and the CISPR 22 conducted emission limits extend from 150 kHz to 30 MHz. A Line Impedance Stabilization Network (LISN) is used to perform conducted emission measurement.

Radiated emission refers to the unintentional release of electromagnetic energy from an electronic device. In general radiated emissions are usually associated with non-intentional radiators, but intentional radiator can also have unwanted emissions at frequencies outside their intended transmission frequency band. These intentional and unintentional radiators can be monopole, dipole or loop antennas. The frequency range of measurement for domestic radiated emission is from 30 MHz to 1 GHz. In this measurement, product under test is placed at some distance from a well defined antenna and the amount of radiation is measured across the required frequency band. In this process a receiving antenna is kept at the far field of the radiating body. Far field is the field where radiation pattern does not change shape with distance. This region is dominated by radiated fields where E and H fields are orthogonal to each other and the direction of propagation.

Deepak Kumar Behera - ([deepak@freescale.com](mailto:deepak@freescale.com)) and Swapnil Tiwari ([b36245@freescale.com](mailto:b36245@freescale.com)) are Design Engineers at Freescale – [www.freescale.com](http://www.freescale.com)  
Sumit Varshney ([b17255@freescale.com](mailto:b17255@freescale.com)) is staff Design Engineer.  
Sunaina Srivastava ([b18098@freescale.com](mailto:b18098@freescale.com)) is Lead Design Engineer, also at Freescale

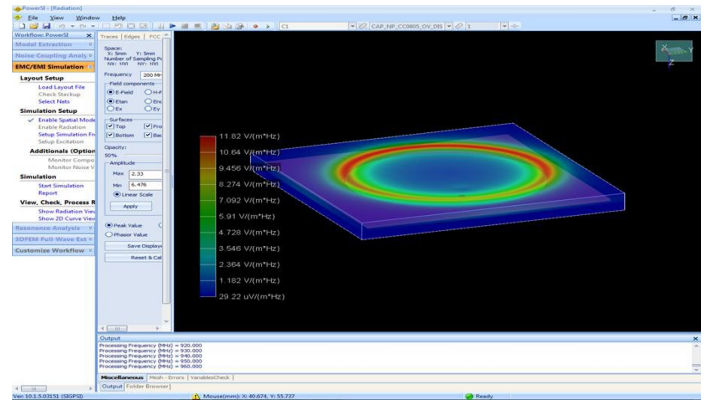

Fig. 1: Near field at 200 MHz

### Far field & near field

The electromagnetic field surrounding an antenna can be divided in 3 regions i.e. Reactive Near Field, Radiating Near Field and Far Field. Far field patterns give information about the radiation. At the most they can inform about the geometry by using scattering methods but they are not helpful in locating the source of EMI. The antenna used for measuring the far field is too big to detect the source. In contrast, near field probes are used to locate the EMI sources. They can locate the exact source of emission on the spot. However there is very little correlation between the near field and far field measurements. Though, the higher the radiation in the near field, the higher it will be in the far field. The test performed in the near field gives the data which can be used to predict the behaviour of the far field. This can be used to find out the frequency band where the radiation will be maximal. In this article we use the same property in our simulation to correlate the near field and far field data.

The FCC measurement distance is 3m for Class B products and 10m for Class A products. For CISPR 22 (EN55022) the measurement distance is 10m for Class B products and 10m for Class A products. The lower frequency of 30MHz is one wavelength at 10m, whereas the frequency of 1GHz is one wavelength at 30cm. When we are measuring the far field we are looking for uniform plane waves whose phase is equal at an instance of time. The distance from where the far field of any antenna start is  $2D^2/\lambda$ , where D is the maximum linear dimension.

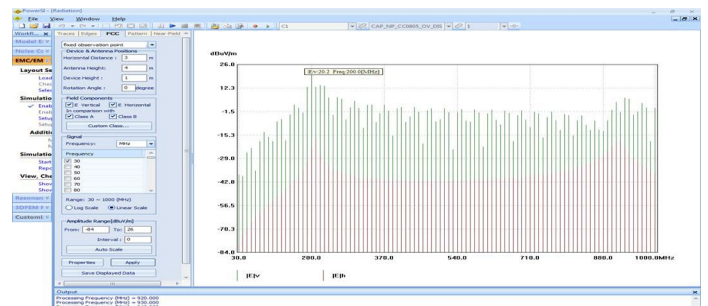

Fig. 2: Far field radiation at 200 MHz

sion of the antenna and  $\lambda$  is the wavelength. If we increase the distance from  $2D^2/\lambda$  we will get waves with the same phase so there will be less measurement errors. Because the radiation pattern doesn't change in this region, we can keep the receiver antenna at a long distance, which is taken as  $\lambda$  by FCC. As the test probe gets closer to the source, the nature of the electromagnetic field changes because we are in the Reactive Near field region where E and H fields are in quadrature.

The electromagnetic field is characterized by its wave impedance which is the ratio of transverse component of electric and magnetic fields i.e.

$$Z = E/H$$

The wave impedance or the intrinsic impedance of free space is  $120\pi$  or 377 ohms where the measurement is done.

### Simulation & result

We simulated a board using the Power SI tool of Sigrity for the analysis of near field and Far field radiation following the FCC regulations. In this setup, the board has been excited using a source and the probable radiation sources like traces and edges have been selected to check the level of emission. An FCC test condition is already available in the tool with the given regulations for class A and class B. As we know that the far field measurements do not help in locating the source of problem, we also perform a near field analysis. One thing which is certain is that if the radiation is more important in some frequency band of the near field band it will also be more important in the far field for the same band.

The near field plotting is available in Sigrity's tool (Power SI), which provides a convenient way to study the hotspots on a given structure. We defined a box where the near field is going to be plotted. Similarly far field radiations can also be measured using this tool. In this measurement tool, the user defines a receiver antenna at a specified distance and then measures the radiation. Radiation patterns in the form of  $E_v$ ,  $E_h$ ,  $E_\theta$  and  $E_\phi$  can be plotted using this facilities.

The Near field radiation has been observed for the whole frequency band (30 MHz – 1 GHz) and it is found that it is maximal at 200 MHz as shown in figure1. The far field has been measured by following the same limitation given in FCC regulation. To cross check the property we have obtained the result for far field measurement. We noticed that the radiation is maximal at 200 MHz as shown in figure 2.

We can conclude that the standard far field compliance test for radiated emission is not well suited for the early stages of product development. The near field can be used to locate the source of EMI which is useful in early stage of design as it can reduce the cost. Early knowledge of radiation can tell the designer where to shield the radiating bodies. Besides this the far field setup requires an anechoic chamber vector network analyzer, VSWR meter etc which is a costly setup. On the other hand near field probes are cheap. Hence, one can perform a near field test to modify the design in the early stages of development to limit the probabilities of radiated emissions.

# When 4 channels are not enough...

A unique 8 channel Mixed Signal Oscilloscope which provides comprehensive measurement and analysis capabilities for embedded, automotive, power and mechatronics applications

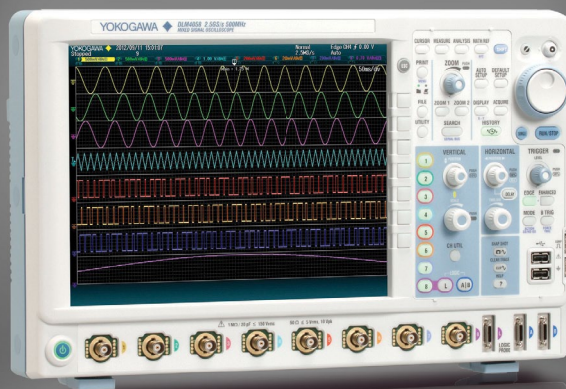

#### DLM4000 Series

- 8 analogue channels
- Up to 24 digital inputs
- Up to 500 MHz bandwidth
- Up to 125M points long memory

Solve your complex measurement requirements faster and easier than ever before



Watch the video at: <http://bit.ly/T1gLUh> and contact us to see how the DLM4000 can help you.

QUALITY ■ INNOVATION ■ FORESIGHT

  
**YOKOGAWA**  
 YOKOGAWA EUROPE B.V.  
 Tel.: + 3188 464 1429  
 tmi@nl.yokogawa.com  
 http://tmi.yokogawa.com

# Validating test evidence to reduce supply chain risk

by Jean-Louis Evans

**TO MEET THE DEMAND FOR LOW-COST GOODS**, companies are increasingly buying directly from manufacturers outside the EU. While such products must bear the CE marking, this is not a sign of safety or compliance. Relying on a CE marking could put an EU company's brand reputation at stake as they may be purchasing unsafe goods. They must therefore go beyond gathering evidence that a product complies with CE marking requirements, they must validate that evidence as correct to ensure that their supply chain complies.

A technical file is the evidence that a product has been tested correctly and proves compliance, not solely a CE marking on a product.

Ultimately it is the company that places the item for sale within the EU market that is responsible to prove CE marking compliance, but they should push further down their supply chain to the manufacturer to provide the evidence in the form of test reports and certification.

A CE marking declaration of conformity (a single piece of signed paper) is not proof – the technical file is

If a manufacturer can incorrectly affix a CE marking, how can you be sure that the products have been tested correctly to produce the technical file? As the retailer, importer or manufacturer using components, you need to check that CE marking has been applied correctly by validating the evidence shown to you.

Do the relevant reports and certificates match the correct product? Are they less than two years old? – this is what TÜV recommends as over time reports do not relate to the product in its current form due to material and manufacturing changes. Ensure that the tests are relevant to the current requirements and don't use out of date standards.

Very often products supplied are not the same as those ordered (if for example they were seen at a trade show) due to production costs reduction.

Ideally compliance testing should therefore be done pre-shipment to validate the evidence that the product has been tested and certified or the buyer should request it as part of the contract condition.

Factory inspections can also be carried out to check the

authenticity of factories as often mass-production is done in a different facility.

Save yourself time and hassle by selecting products which have already been tested and certified, asking for pre-reproduction samples and compliance documentation for evaluation. Such products may carry a price premium, but they will help

to protect brand reputation and save costs further down the line when validating the evidence becomes more burdensome.

Ensure that any factory you deal with outside the EU has a Quality Management System in place and is regularly audited.

Do consider pre and/or post shipment inspections, taking random samples from boxes to ensure that the goods meet expectation.

Before the products are sold in the EU, send samples for a 'spot-check' so that they, and their test and certification evidence, can be verified as being compliant.



**Fig. 1:** Some products that would fail tests are still given a CE marking.

TÜV SÜD Product Service has launched a Field Labelling service to help UK and European manufacturers of electrical and electronic equipment export to the USA more easily.

Field Labelling is a mandatory requirement for most bespoke electrical and electronic equipment used in manufacturing or

commercial sites in the USA. Premises that use uncertified equipment can be fined or shut down. TÜV SÜD is one of only 18 Nationally Recognized Testing Laboratories (NRTLs) in the world that are allowed by the Occupational Safety and Health Administration (OSHA) to perform this field evaluation activity.

The new TÜV SÜD service reduces complexity and cost, as it offers European manufacturers a combined local and USA based service, as well as a next-day option for time-sensitive projects. TÜV SÜD Product Service engineers will visit the European manufacturer on-site to complete

an initial evaluation of the equipment against compliance requirements. Once the equipment is installed in the USA, TÜV SÜD's local engineers will complete the process, verifying the original evaluation report and confirming the installation is in accordance with the specific requirements.

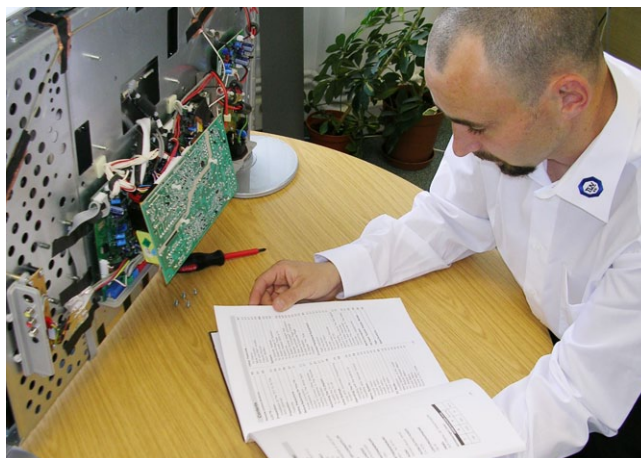

**Fig. 2:** Retailers often test goods themselves to ensure products meet CE marking requirements.

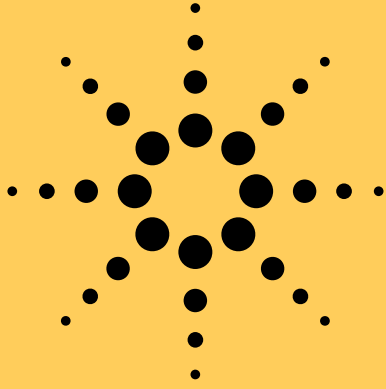

# Agilent Basic Instruments

December 2012 – February 2013



**Generating true waveforms: Low-cost signal generation without the compromise**

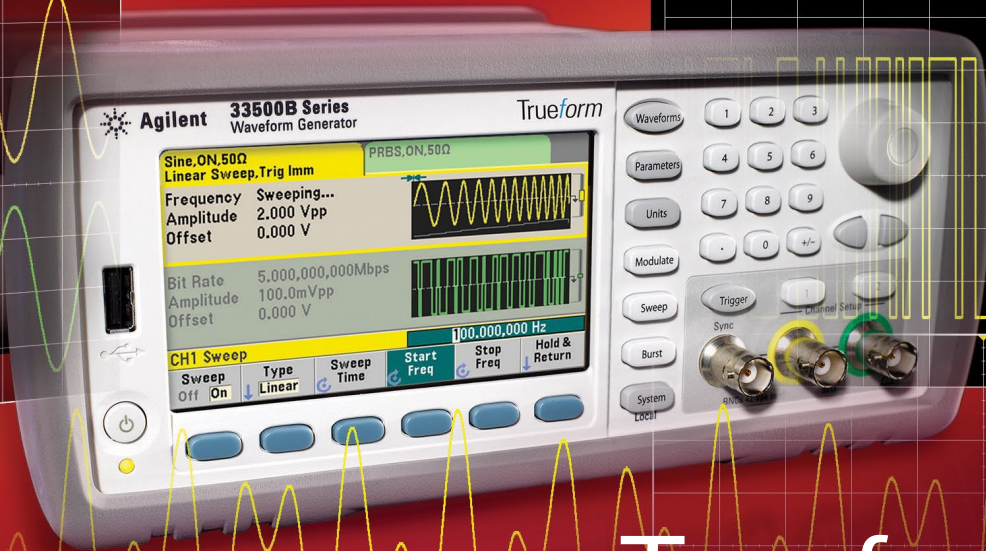
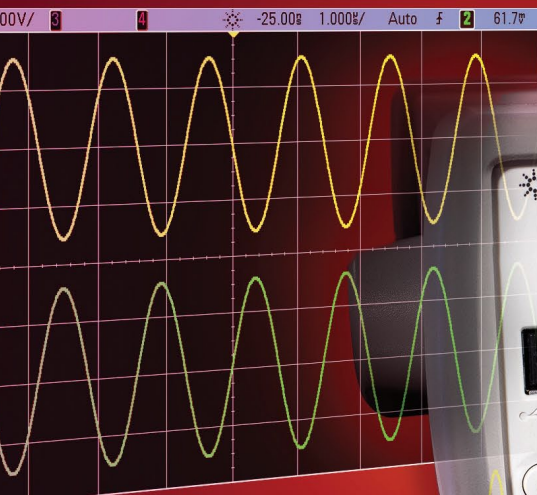

With **Trueform**  
TECHNOLOGY



Great offers on a wide variety of Agilent products



**Free Bluetooth adapter with the purchase of a handheld digital multimeter**

Turn your Android smartphone or tablet into a remote measurement, control, and reporting device. With the purchase of a new Agilent handheld digital multimeter receive a free bluetooth adapter. Offer available through Feb. 28, 2013.



**Free Set of Precision DMM Probes when you buy a Benchtop DMM**

Customers who purchase a new 34401A, 34405A, 34410A, or 34411A DMM and register their product online are eligible to receive a FREE set of 34133A precision probes. Offer available through Feb. 28, 2013.



**Receive a Free Handheld Product With the Purchase of an E3600 Power Supply**

Customers who purchase an eligible E3600 power supply product are eligible to receive a FREE U1272A handheld digital multimeter. Offer available through Feb. 28, 2013.



**Receive 30 MHz 33500B Series Waveform Generator for the Price of 20 MHz**

Customers who purchase a new 30 MHz 33500B Series Waveform Generator are eligible to receive it at the price of a 20 MHz waveform generator. Offer available through Feb. 28, 2013.



**Get Four free 1 GHz active probes**

Achieve 1 GHz full system bandwidth to the probe tip with your purchase of a new InfiniiVision 4000 X-Series 1 GHz or 1.5 GHz oscilloscope. *Probes ship automatically with scope.* Valid through May 31, 2013.



For more information, go to: [www.agilent.com/find/promos](http://www.agilent.com/find/promos)

Agilent



Our Distributor Network

Right Instrument. Right Expertise. Delivered Right Now.

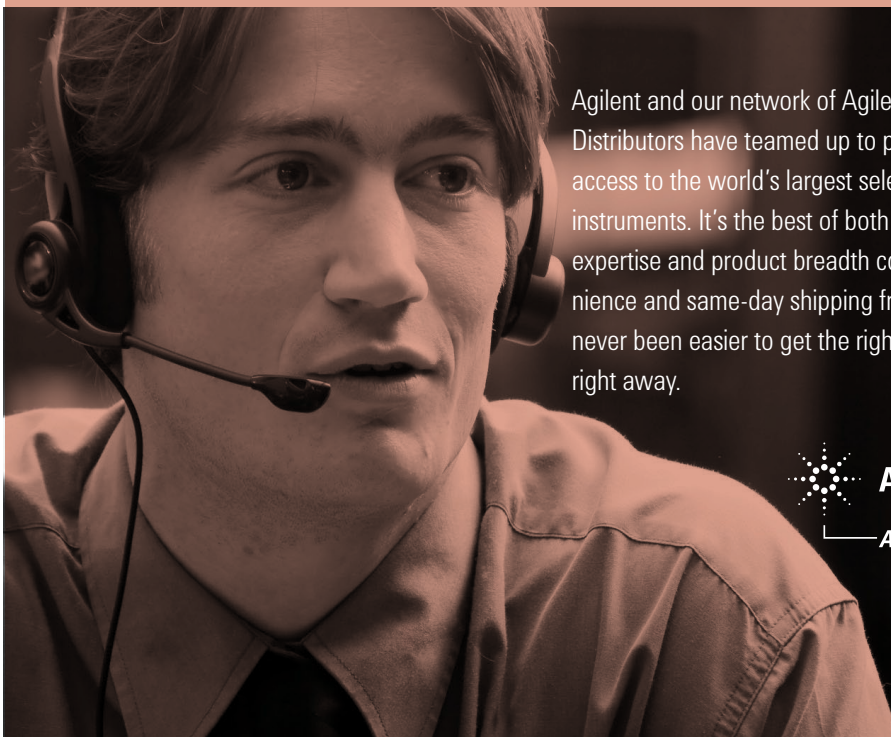

Agilent and our network of Agilent Authorised Distributors have teamed up to provide fast, easy access to the world's largest selection of off-the-shelf T&M instruments. It's the best of both worlds: Agilent's measurement expertise and product breadth combined with speed, convenience and same-day shipping from our distribution partners. It's never been easier to get the right instrument in the right hands, right away.



Agilent Technologies

Authorised Distributor

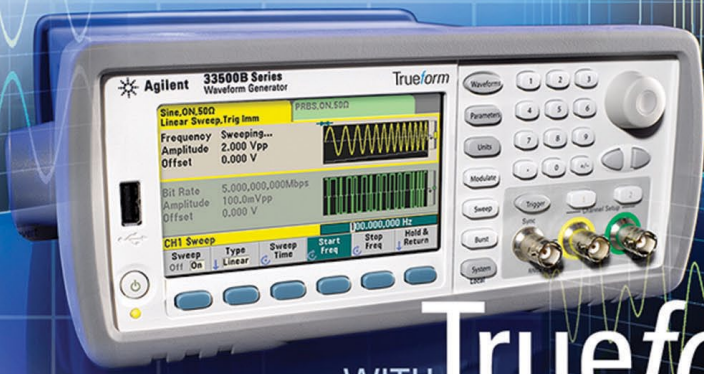

WITH **Trueform**  
TECHNOLOGY

## When an approximation isn't good enough: generating a true waveform

The technologies used to digitally generate analog waveforms have long been a case study in compromise.

### Precise but expensive

The point per clock (PPC) method, in which each point of the waveform file is cycled through a DAC, is conceptually simple but requires complicated and expensive clocking and filtering in order to be successful in real-world applications.

### Low cost but approximate

The approach widely used for mainstream function/arbitrary waveform generators, direct digital synthesis (DDS), is simpler and far less expensive but renders approximations of the desired waveform. These approximations are acceptably close to the ideal for many applications, which is why lower-cost waveform generators typically use this technology.

However, because these signals are approximations, there can be problems with harmonic distortion, jitter, aliasing, and even skipped points in the waveform.

### Low cost—without compromise

Engineers now have a third option that combines the best of both worlds: exclusive Trueform signal generation technology available in the Agilent 33500B Series waveform generators. Trueform works by employing a virtual variable clock with advanced filtering that tracks the sample rate of the waveform. The result is the performance of PPC technology at the same price point as DDS generators.

**FIGURE 1**, for example, shows the twelve-fold reduction in jitter that Trueform offers over a traditional DDS generator. Lower jitter increases the precision of timing-related tests, a key advantage with edge-based timing applications such as clocks, triggers, and many communication signals.

**FIGURE 2** highlights another major advantage: high-fidelity signals that eliminate the point-skipping problems of DDS. With a DDS, the higher the frequency, the more likely gaps will appear in the output waveform—increasing the odds that the generated signal will be missing critical details.

Other major advantages of Trueform include total harmonic distortion up to five times lower than DDS and full anti-aliasing with no external filtering required.

With these improvements in signal integrity, the Agilent 33500B Series waveform generators with Trueform are especially useful for the following applications:

- Simulating clock signals
- Testing serial data buses by streaming standard PRBS patterns
- Providing precise timing control, such as a trigger source or gate controller
- Economically playing baseband IQ signals (option IQP)

To learn more about this revolutionary approach to waveform generation, visit [www.agilent.com/find/33500B](http://www.agilent.com/find/33500B)

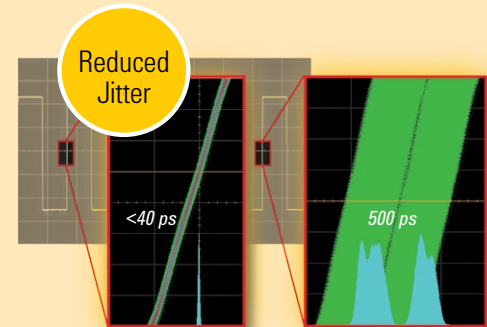

**FIGURE 1**

Trueform (left) exhibits up to 12 times less edge jitter than conventional DDS generators (right).

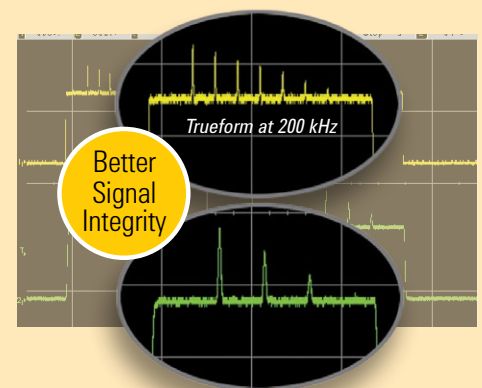

**FIGURE 2**

This 200 kHz signal was programmed with seven spikes riding on the square wave. Trueform (upper) successfully created all seven spikes, but the waveform from a DDS generator (lower) is missing four of the seven.

## High performance

*Anticipate new demands with modular versatility, deep accuracy, and high speed*

### N6700 low-profile modular power system



- Ideal DC power supply solution for Automated Test Systems: small, fast, and flexible
- Small 1 U high mainframe (400, 600, 1200 W) with slots for up to 4 programmable DC power modules
- Industry leading fast command processing time (<1 ms) to improve throughput
- Mix and match the performance you need with your choice of over 25 programmable DC power modules: Basic, high performance, and precision (mA &  $\mu$ A); available in 50, 100, 300, and 500 W
- USB, GPIB and LAN (LXI-C) connectivity

7 new modules up to 500 W!

### N6705B DC power analyzer



- Get deep insight into DUT power consumption—without assembling a complex test system
- Integrate up to four DC programmable power modules with DMM, scope, arb, and data logger features; up to 600 W total power
- USB, GPIB and LAN (LXI-C) connectivity

### 6600 Series high-performance DC supplies



- Fast, low-noise outputs improve measurement accuracy and test throughput
- 40 to 6600 W, 1 to 4 outputs, up to 120 V, and up to 875 A
- Programmability and built-in V & I measurements simplify test setups
- GPIB connectivity

### N3300 DC electronic load mainframe



- Stable and accurate: these loads are easy to integrate into your test system
- Automated command list execution reduces workload on system controller
- 1800 W mainframe accepts up to six 150 to 600 W modules for simultaneous testing
- Maximum inputs up to 240 V and 120 A
- GPIB connectivity

## High value

*Solid performance and robust features help you achieve more on lower budgets*

### N5700 and N8700 Series system DC power



- Basic, high-power, single output power supplies
- 45 affordable models in compact 1U (750 and 1500 W) and 2U (3.3 and 5 kW) packages
- Up to 600 V or up to 400 A
- Programmability and built-in V & I measurements simplify test set ups
- USB, GPIB and LAN (LXI-C) connectivity

### E3600 Series DC power



- Output noise as low as 1 mVp-p/0.2 mVrms
- Tight 0.01% load and line regulation
- Fast load transient response time (<50  $\mu$ s)
- 30 to 200 W outputs

### U8000 Series DC power supplies



- Output sequencing (for U803x Series)
- Low output noise (as low as 1 mVrms) minimizes interference into your device-under-test (DUT)
- Fast load transient response time (< 50  $\mu$ s) reduces test time and manufacturing cost
- Excellent 0.01% load and line regulation for steady output power levels
- Total power of 375 W at three outputs (for U803x Series)

### 6030 Series basic autoranging DC supplies



- Autoranging to do the job of multiple power supplies
- 240 to 1200 W outputs, up to 500 V and up to 120 A
- Programmability and built-in V & I measurements simplify test setups
- GPIB connectivity

### 82350B PCI high-performance GPIB interface



- Easily control instruments and exchange data with maximum throughput, and comes with built-in buffering for speeds up to 900 KB/s.

### 82357B USB/GPIB interface



- Comes with high-speed USB 2.0 with fast, easy, plug-and-play connection and auto configuration, and offers a GPIB transfer rate of up to 1.15 MB/s

### E5810A LAN/GPIB gateway



- Share equipment and collaborate globally
- 10 Base-T/100 Base-TX LAN for remote control of GPIB instruments
- Digital display and built-in Web browser for easy setup/configuration

# HINT

## MEASUREMENT

The Watt's Up blog offers dozens of articles with practical advice on power products. Get insights on selecting supplies and electronic loads, understanding specifications, configuring and programming supplies and meeting a variety of application challenges. To learn more, visit

<http://powersupplyblog.tm.agilent.com>



*Breakthrough scope technology lets you see more, do more and get more for your money*

**1000 Series oscilloscopes**



- 50 to 200 MHz, 2 and 4 channel DSO models with up to 20 kpts memory
- 5.7-inch color display offers powerful signal capture and display
- Up to 2 GSa/s sample rate
- 23 automatic measurements, sequential acquisition, mask testing and digital filters provide advanced measurement capabilities
- Accelerate your productivity with an 11-language user interface, USB connectivity, and a standard educator's kit

**InfiniiVision 2000 X-Series oscilloscopes**

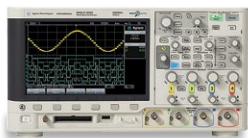

- 70 to 200 MHz bandwidth, 100 kpts memory, DSO and MSO models
- Up to 50,000 waveform updates/second
- 8.5-inch WVGA display offers 2x the viewing area and 5x the resolution of competitive scopes
- Fully upgradable—bandwidth, MSO, WaveGen built-in 20 MHz function generator, and integrated digital voltmeter

**InfiniiVision 3000 X-Series oscilloscopes**



- 100 MHz to 1 GHz bandwidth, up to 4 Mpts memory, DSO and MSO models
- Up to 1,000,000 waveform updates/second
- 8.5-inch WVGA display is 50% larger and 3x the resolution of competitive scopes
- MegaZoom IV responsive, uncompromised smart memory with segmented memory optional
- Fully upgradable—bandwidth, MSO, memory, WaveGen built-in 20 MHz arb/function generator, integrated digital voltmeter, and serial analysis

**InfiniiVision 4000 X-Series oscilloscopes**



- 200 MHz to 1.5 GHz bandwidth, 4 MPts memory standard, DSO and MSO models
- Up to 1,000,000 waveform updates/sec
- 12.1-inch capacitive touch display—40% larger than competitive scopes
- Industry's only InfiniiScan Zone touch triggering
- MegaZoom IV uncompromised smart memory with segmented memory standard
- Fully upgradable—WaveGen built-in 20 MHz arb/function generator, integrated digital voltmeter, and serial analysis including USB

*Experience speed, usability and integration.*

*Gain greater insight with powerful applications – see the complete list; [www.agilent.com/find/scope-apps](http://www.agilent.com/find/scope-apps)*

| Description                     | 2000 X-Series | 3000 X-Series | 4000 X-Series |
|---------------------------------|---------------|---------------|---------------|
| 20 MHz WaveGen                  | DSOX2WAVEGEN  | DSOX3WAVEGEN  | DSOX4WAVEGEN2 |
| 3-digit voltmeter               | DSOXDVM       | DSOXDVM       | DSOXDVM       |
| DSO to MSO upgrade              | DSOX2MSO      | DSOX3MSO*     | DSOXPERFMSO   |
| I2C/SPI trigger/decode          |               | DSOX3EMBD     | DSOX4EMBD     |
| RS232/UART trigger/decode       |               | DSOX3COMP     | DSOX4COMP     |
| NEW USB full/low trigger/decode |               |               | DSOX4USBFL    |
| NEW USB high trigger/decode     |               |               | DSOX4USBH     |

2-ch AWG

\*1 GHz models require DSOXPERFMSO

Get a **FREE 14-Day Trial License.** [www.agilent.com/find/14daytrial](http://www.agilent.com/find/14daytrial)

*Maximum versatility to troubleshoot today's challenges and anticipate tomorrow's needs*

**U1600 Series handheld scopes**



- 5.7-inch VGA TFT LCD display with indoor, outdoor, and night-vision viewing modes
- 3-in-1 instrument: scope, DMM, and data logger
- Two independent, isolated channels (U1610A, U1620A)
- Up to 2 GSa/s sample rate and up to 2 Mpts deep memory to zoom in on critical details
- Benchtop-like dual window zoom for more detailed waveform analysis

*Anticipate every new challenge with reconfigurable portable test systems*

**USB modular instruments and data acquisition**



- Mix and match the USB modular instruments, DAQ modules or switching I/O units to meet your measurement needs
- Instrument and DAQ modules can be used standalone or integrated together in the USB modular chassis
- Hi-speed USB 2.0 interfaces for easy setup, plug-and-play, and hot swappable connectivity
- U2781A USB modular product chassis can host up to six modules and synchronize multiple instruments
- Bundled Agilent Measurement Manager lets you configure and control a system with no programming

**USB modular instruments (U2700 Series)** includes 100/200 MHz oscilloscopes, 3-channel source measurement unit, 5 ½ digit DMM, switch matrix, and function generator. For more information, go to [www.agilent.com/find/usbmodular](http://www.agilent.com/find/usbmodular)

**USB modular data acquisition (U2300 Series and U2500 Series)** includes multifunction and simultaneous sampling multifunction DAQ devices. Additional I/O devices and RF switch driver are also available. For more information, go to [www.agilent.com/find/usbdaq](http://www.agilent.com/find/usbdaq)

See PROMO Page 2

NEW

**Achieve more on a tight budget: Solid performance with robust measurement features**

**N9310A  
RF signal  
generator**



- 9 kHz to 3 GHz CW output, 20 Hz to 80 kHz low frequency (LF) output
- -127 to +13 dBm output level range (max +20 dBm settable)
- -95 dBc/Hz SSB phase noise
- Extensive analog modulation: AM, FM, phase, and pulse modulation
- Optional IQ modulator, 40 MHz bandwidth
- Up to +/- 0.1 ppm aging rate

**N9320B RF  
spectrum  
analyzer**



- PowerSuite: high-confidence answers with simple one-button measurements of channel power, occupied bandwidth and other key parameters
- AM/FM and ASK/FSK demodulation analysis
- LAN, GPIB, and USB connectivity
- Frequency range: 9 kHz to 3 GHz
- DANL: -148 dBm with pre-amp on
- RBW: 10 Hz to 1 MHz
- Free remote control PC software

**Modular flexibility and universal channels for a wide range of measurements with no external signal conditioning**

**34970A/72A  
data acquisition  
switch unit, 6½  
digit**



- 34972A offers: LAN built-in web interface for easy control and interface
- 3 slot mainframe, built-in signal conditioning for 11 types of input signals
- Free BenchLink Data Logger software eases setup and documentation, 34830A BenchLink Data Logger Pro software also available
- GPIB and RS-232 connectivity (34970A), USB and LAN (LXI-C) connectivity (34972A)

**34970A/72A plug-in modules**

| Model                              | Key specifications                 |
|------------------------------------|------------------------------------|
| <b>34901A/02A/08A multiplexers</b> | Up to 300 V, 16, 20, or 40 channel |
| <b>34903A GP switch</b>            | 300 V, 20 actuator channel         |
| <b>34904A matrix</b>               | 4x8 matrix – 300 V                 |
| <b>34905A/06A RF switches</b>      | 2 GHz dual, 50 and 75 Ω            |
| <b>34907A multi-function</b>       | DIO, DAC, totalizer                |

**The cost-effective way to accelerate production line LCR testing and improve component evaluation**

**4263B LCR meter**



- 100 Hz to 100 kHz
- 0.1% basic accuracy
- High-speed measurement: 25 ms
- 6 test frequencies: 100 Hz, 120 Hz, 1 kHz, 10 kHz, 20 kHz, 100 kHz

**Accomplish even more with higher speeds, greater capability, and better value**

**34401A digital  
multimeter, 6½  
digits**

See  
PROMO  
Page 2



- Basic accuracy: 0.0035% DC, 0.06% AC
- 12 measurement functions, plus limit testing and statistics give meaningful answers in less time
- 1,000 readings/s in ASCII format across the GPIB interface

**34410A/11A  
enhanced perfor-  
mance multimeter,  
6½ digits**

See  
PROMO  
Page 2



- Upgrade to a faster, more accurate multimeter with additional functions
- 10,000 readings/s at 5½ digits (34410A), 50,000 readings/s at 4½ digits (34411A)
- 14 measurement functions including capacitance and temperature; built-in data logging
- 50,000 reading non-volatile memory
- USB, GPIB, and LAN (LXI-C) connectivity

**34405A digital  
multimeter, 5½  
digits**

See  
PROMO  
Page 2



- Simultaneous reading of DC and AC measurements on dual display
- 5½ digits, 120,000 counts resolution
- 16 measurement functions including temperature and capacitance
- 0.025% DC voltage accuracy
- USB connectivity

**U3400 Series digi-  
tal multimeters,  
4½ and 5½ digits**



- Low-cost basic dual display DMMs for tight budgets
- 120,000 counts resolution (50,000 count for U3401A)
- Up to 0.012% DC voltage accuracy
- 11 basic measurements including DC and True RMS AC and AC+DC voltage and current, selectable 2- or 4-wire resistance (2-wire only for U3401A)

**U3606A multi-  
meter/DC power  
supply**



- Convenient combination of DMM and power supply
- DMM: 120,000 counts resolution with DC voltage accuracy 0.025%
- Power supply: Dual range 30 V / 1 A or 8 V / 3 A output with OVP and OCP protection
- USB TMC 488.2 and GPIB connectivity

Retool your expectations of handheld test tools, with high performance in the harshest environments

NEW



**U1270 Series handheld DMMs**

See PROMO Page 2



- Featuring the new U1273AX, with 30,000-count resolution, 0.05% basic DCV accuracy, and dependable performance down to -40°C
- OLED display with superior contrast and wide viewing angle
- Improve productivity with low impedance mode, low pass filter, offset compensation
- Both visual and audible continuity indication in noisy environments
- Operating altitude up to 3000m
- Dust and water resistant casing (certified to IP 54)

**U1177A Infrared (IR)-to-Bluetooth® adapter\***



- Add wireless connectivity to U1230, U1240, U1250 and U1270 series handheld DMMs
- Monitor and log data remotely on your Android device from up to 10 meters away
- Certified to -40°C: monitor from a warm, safe environment while your meter does the work
- Easily attaches to the meter's IR port

**U1583B current clamp**



- Dual range (40A and 400A) AC current clamp for handheld DMMs and scopes
- 10 mV/A and 1 mV/A output
- CAT III 600V OV protection
- Certified to -40 °C



**VIDEO**

See the U1273AX handheld in action at -40 °C!

Visit <http://tinyurl.com/ce9yv9d> or scan this QR code to watch the U1273AX operating even at -40 °C

\* Current country type approval allows the U1177A to be shipped only to the following countries: Australia, Algeria, Benin, Brazil, Burkina Faso, Cameroon, Canada, Central African Republic, China, Colombia, Democratic Republic of Congo, El Salvador, Equatorial Guinea, European Union, Gabon, Guatemala, Hong Kong, Iceland, India, Israel, Ivory Coast, Japan, Kazakhstan, Korea, Lebanon, Liechtenstein, Madagascar, Malaysia, Mali, Mexico, New Zealand, Niger, Norway, Panama, Rwanda, Singapore, Switzerland, Taiwan, Thailand, Togo, Turkey, United States.

Validate your most challenging designs with realistic test signals using exclusive Trueform technology

NEW

**33500B Series waveform generators**

See PROMO Page 2



- Exclusive new Trueform waveform technology with lowest jitter and harmonic distortion and highest signal fidelity
- Arb models include 1 M (16 M optional) memory and embedded editor; non-arb models upgradable to arb capability
- Sine waves, square, ramp, triangle, noise, pulse generation with variable edge, DC waveforms, AM, FM, and more
- USB, GPIB and LAN(LXI-C) connectivity (33250A GPIB and RS232 only)

| Model                | Description  |
|----------------------|--|
|                      | 33500B Series:<br>16-bits, 250 MSa/s, 1 M point (optional arb),<br>20 and 30 MHz pulse, less than 40 ps jitter |
| <b>33509B/33511B</b> | 20 MHz, 1-Channel (optional arb) / with built-in arb   |
| <b>33510B/33512B</b> | 20 MHz, 2-Channel (optional arb) / with built-in arb   |
| <b>33519B/33521B</b> | 30 MHz, 1-Channel (optional arb) / with built-in arb   |
| <b>33520B/33522B</b> | 30 MHz, 2-Channel (optional arb) / with built-in arb   |
| <b>33210A</b>        | 10 MHz, 1 chnl, 14-bit, 50 MSa/s, 8 K point (optional arb)   |
| <b>33220A</b>        | 20 MHz, 1 chnl, 14-bit, 50 MSa/s, 64 K point, 5 MHz pulse  |
| <b>33250A</b>        | 80 MHz, 1 chnl, 12-bit, 200 MSa/s, 64 K point, 50 MHz pulse  |
| <b>33502A</b>        | Isolated amplifier, dual channel, 50 V peak-to-peak  |
| <b>33503A</b>        | BenchLink Waveform Builder Pro Software  |

Achieve deep insights quickly with histograms, trend charts and statistics

**RF and universal frequency counters**

- Up to 20 ps single-shot time interval measurements
- Histograms, trending, data logging, and built-in math and statistics functions give greater insights into system behavior
- Frequency, frequency ratio, time interval, rise/fall time, phase, and much more
- Continuous, gap-free measurements, with time stamps on signal edges (53230A only); pulse/burst microwave measurements (53230A only)
- Optional 6 GHz or 15 GHz RF channel
- USB, GPIB and LAN (LXI-C) connectivity



| Model         | Description  |
|---------------|--|
| <b>53210A</b> | 350 MHz RF Frequency Counter, 10 digits/s                      |
| <b>53220A</b> | 350 MHz Universal Frequency Counter/Timer, 12 digits/s, 100 ps |
| <b>53230A</b> | 350 MHz Universal Frequency Counter/Timer, 12 digits/s, 20 ps  |



Get a quick quote today at [www.agilent.com/find/quick-quote](http://www.agilent.com/find/quick-quote)

**NEW**

## The oscilloscope experience redefined: InfiniiVision 4000 X-Series oscilloscopes

These 200 MHz to 1.5 GHz oscilloscopes deliver waveform update rates 20 times faster than the competition, the power of MegaZoom IV smart memory, and an intuitive GUI—all with a capacitive touchscreen interface.

**Experience the uncompromised speed** of the ability to find the most difficult problems in your design with 1 million waveforms/sec update rate, MegaZoom IV smart memory and standard segmented memory.

**Experience the usability** of the first scope designed for touch capability with the industry's largest 12.1-inch capacitive touch display and innovative InfiniiScan Zone touch triggering.

**Experience the integration** of 5 instruments in one: oscilloscope, logic analyzer, serial protocol analyzer, WaveGen dual channel arbitrary/function generator, and 3-digit voltmeter, with the ability to upgrade your scope at any time for complete investment protection.

To learn more, visit: [www.agilent.com/find/4000X-Series](http://www.agilent.com/find/4000X-Series)



**New Trueform signal generation technology: high-end performance at budget-friendly prices. See page 3.**

*Bluetooth* and the *Bluetooth* logos are trademarks owned by *Bluetooth SIG, Inc.*, U.S.A. and licensed to Agilent Technologies, Inc.

Technical data and pricing subject to change without notice.

Published in Spain November 1, 2012

© Agilent Technologies, Inc. 2012

5991-1139EEE

**Anticipate — Accelerate — Achieve**



**Agilent Technologies**

## “Green” pathways for test, measurement and instrumentation

By Todd Nelson and Clarence Mayott

**LONG AGO, PRECISION** electrical measurements were performed in pristine laboratory environments where ample electricity was available and time was allotted to assure extreme accuracy. Today, the instrument is expected to be ported to the field, running on battery power and achieving even greater accuracy instantly. Analogue circuitry does not benefit from the scaling effects of smaller geometries in the same manner as digital circuitry. Noise, the enemy of precision measurements, actually increases if less power is consumed. And the signal-to-noise ratio (SNR) understandably gets worse with new low voltage processes as the signal amplitude is decreased. Then how does the analog signal chain “go green” while increasing performance?

The core of many fast instruments is a high speed analogue to digital converter (ADC). For example, non-destructive testing of metal objects uses an imaging technique similar to medical ultrasound, where a digital image sensor feeds a high speed ADC. In some cases there are a great many channels, so the size and power consumption are key. Portable instruments obviously need to conserve battery power, but even fixed installations are power conscious – whether for “green” initiatives or simply to minimize heat dissipation in compact form factors. The trend in ADCs is to move to smaller process geometries and use 1.8V supplies to reduce the power, but clever ADC design is required to achieve the same or better performance as similar 3V devices.

Linear Technology has developed several pin-compatible families of 1.8V ultralow power 12-/14- and 16-bit ADCs at sample rates up to 125MSPs that provide excellent dynamic performance at very low power levels. Without eliminating functions or increasing the front-end amplifier requirements, the new devices dramatically reduce power consumption. By providing a choice of single, dual, quad and octal ADCs, customers can achieve high channel density while ensuring the lowest heat dissipation in their system. However, the ADC is only part of the chain. The entire signal chain must be well matched for the instrument to be successful.

### Matched signal path design

The LTC2195 family is an ideal solution for applications that require 16-bit performance and ultralow power consumption to extend battery life. Portable instrumentation is a perfect example. In many applications the signal from the sensor must be conditioned before being sampled by the ADC. For this task, it is important to choose a low noise, low power amplifier that matches the performance of the ADC, such as the LTC6406, which makes a good match for the LTC2195 family.

The LTC6406 is a fully differential amplifier with low noise (1.6nV/√Hz at the input) and high linearity (+44dBm OIP3 at

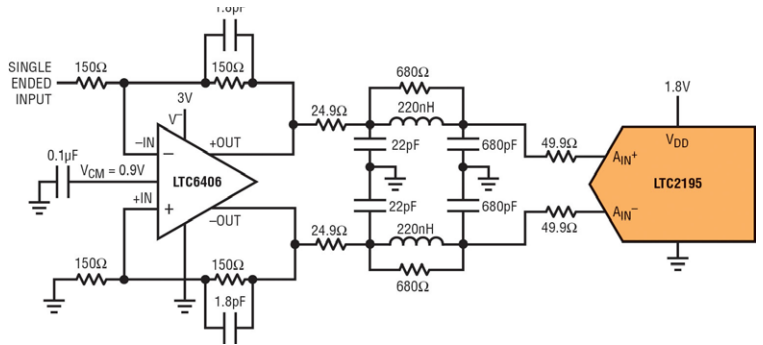

Fig. 1: Single-ended to differential interface to high speed ADC.

20MHz) in a small 3x3mm QFN package. External resistors set the gain, giving the user maximum design flexibility. Low power consumption (59mW with a 3.3V supply) minimizes the effect on the system power budget. This amplifier also has a common mode voltage range that extends down to 0.5V, meaning it can be paired seamlessly with the LTC2195, which has a nominal common mode voltage of 0.9V.

Typically the output of a digital sensor is single-ended. This requires a single-ended to differential translation before being sampled by the ADC. If response to DC is also required, a transformer cannot be used. This situation mandates a low noise amplifier that is capable of doing single-ended to differential translation, like the LTC6406.

The amplifier must be followed by a filter to reduce the wideband noise of the amplifier and to isolate the output of the amplifier from the ADC inputs—the ADC inputs produce common mode glitches associated with the commutation of the sample caps. A filter helps attenuate these glitches, protecting the amplifier. A high order filter is not required, since the noise of the amplifier is fairly low. With a corner frequency of 12MHz, the filter used here is adequate—it does not degrade the performance of the ADC. The final filter should be designed to reduce

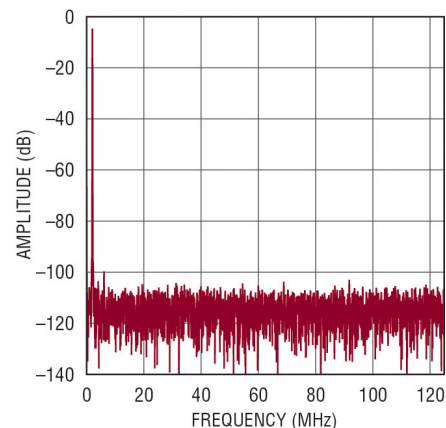

Fig. 2: FFT results of the circuit from figure 1 with FS = 125MSPs and FIN = 1MHz

Todd Nelson is Signal Chain Module Development Manager at Linear Technology  
 Clarence Mayott is Applications Engineer at Linear Technology – [www.linear.com](http://www.linear.com)

only the wideband noise of the amplifier, not as a selectivity filter with a steep transition band. A steep transition band in the filter increases insertion loss and degrades the OIP3 of the amplifier, which leads to distortion of the signal from the sensor. The circuit shown in figure 1 accomplishes this goal.

The ADC used is the LTC2195, a 16-bit 125Msps, simultaneous sampling, dual ADC operating from a single 1.8V supply. At 216mW per channel, this device achieves nearly identical SNR performance as ADCs drawing 1.25W.

The LVDS serial interface allows the part to consume less than half the board space of preceding ADCs and also allows the use of smaller FPGAs due to the reduced number of I/O. Combined with the LTC6406, this circuit consumes only 275mW – an obvious advantage for multichannel systems. This circuit can be easily applied to the 14- or 12-bit members of the family or to converters that sample at much lower sample rates, further saving power.

Figure 2 shows the performance of this circuit. The results show that the linearity of the amplifier does not degrade the SFDR of the ADC at low input frequencies. The SNR also remains unchanged at 76.5dB. The LTC6406 does not degrade the SNR or the SFDR of the LTC2195 when using it at unity gain.

The trend toward “green” instruments and test equipment is inescapable, whether for fixed installations or portable equipment. As performance levels increase and power consumption requirements decrease, it is important to match the components of the entire signal chain.

### MIMO channel emulators with support for multi-link networks and geometric modeling

Azimuth Systems’ latest upgrade to its ACE MX and MX2 MIMO channel emulators feature increased support for multi-link and mesh networks, additional geometric modeling capability, as well as an updated version of Director II test executive software (release 7.6) for enhanced functionality and ease-of-use. The ACE product line of fully-featured channel emulators is designed to accurately recreate complex fading channels for testing the most advanced wireless technology and devices.

As purpose-built, enhanced testing solutions, ACE wireless channel emulators are architected to meet the demanding needs of Multiple-Input, Multiple-Output (MIMO) and orthogonal frequency-division multiplexing (OFDM)-based systems. ACE channel emulators provide a superior platform for testing LTE and other advanced wireless infrastructure equipment and devices, and also includes all of the backwards-compatible channel emulation features to test 2G/3G cellular products. Azimuth’s Director II Test Executive Software Suite lets users configure and manage test equipment as well as devices, and initiate, control, and monitor network and test bed traffic, while enabling the user to record, analyze, and share performance results.

**Azimuth Systems**

[www.azimuthsystems.com](http://www.azimuthsystems.com)

### Programmable dual range DC power supplies for bench and ATE applications

B&K Precision’s 9170/9180 series of programmable dual range power supplies include nine models that provide clean and precise power up to 210W in various configura-



tions of voltage as high as 600V and current as high as 20A. Each model offers two ranges of voltage and current output along with modular interface slots for remote interface configura-

bility. Delivered in rack-mountable, single and dual output model configurations, these DC power supplies are suitable for challenging bench and ATE applications in design engineering labs and electronics manufacturing. Models in the 9170/9180 series feature excellent line and load regulation less than 0.01% + 1mV, 0.01% + 250uA, ripple and noise less than 0.35mVrms, a full numerical keypad with vertical and horizontal cursors for direct entry of voltage and current values, front and rear panel output terminals, remote sense terminals, and a standard SCPI compliant USB interface for remote control. Unique to the 9170/9180 series is its modular interface design and special LED test modes. Users have the option to choose from up to 4 different types of interface cards, which include: LAN and GPIB, Digital I/O and Analog Control, RS485, or RS232. These cards can be easily installed at any time when needed into either of the two modular interface card slots on the power supply’s rear panel. LED test modes can be used to minimize inrush current for safe testing of LEDs.

**B&K Precision**

[bkprecision.com](http://bkprecision.com)

### RF radiation meter simplifies measurement of emissions from industrial equipment

The NIM series RF radiation meter from Link Microtek has been specifically designed to enable plant managers and safety professionals to take quick and easy measurements of emissions from industrial sources such as RF heat sealers, RF induction heaters and semiconductor fabrication equipment.

Manufactured by Narda Safety Test Solutions, the NIM unit provides a straightforward means of ensuring compliance with the permissible exposure limits laid down in the ICNIRP international standard. The battery-powered meter features an isotropic, dual-element probe that simultaneously measures electric and magnetic fields, both of which are required for equipment operating below 300 MHz. Users can toggle between E-field and H-field readings at the press of a button, and the instrument features automatic zeroing at power-on and every 15 minutes. The meter is available in two models: NIM-511 and NIM-513. The NIM-511 has a broad frequency range of 300 kHz to 100 MHz, making it suitable for virtually all equipment operating at ISM (industrial, scientific and medical) frequencies. The NIM-513 operates over the narrower range of 10 to 42 MHz, encompassing the ISM frequencies of 13.56 MHz and 27.12 MHz, which are widely used for semiconductor processing equipment, heat sealers and induction heaters. With an LED-backlit 1.5-inch LCD display, the meter will operate for about 22 hours on a charge of its NiMH batteries. It is supplied with a hard case, power supply and shoulder strap.

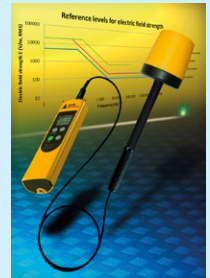

**Link Microtek**

[www.linkmicrotek.com](http://www.linkmicrotek.com)

## eMMC compliance test application

Agilent Technologies announced what the company claims to be the industry's first eMMC (embedded multimedia card) compliance test application for embedded storage solutions.



The Agilent N6465A eMMC test application helps memory design engineers validate and debug eMMC NAND flash memory cards faster by automating the execution of a series of parametric tests, including electrical and timing measurements, on Agilent Infiniium

9000, 90000A, 90000 X- and 90000 Q-Series oscilloscopes. The eMMC NAND flash memory technology can operate at a maximum clock rate of 200 MHz in high-speed mode and provides ultrafast memory for smartphones, tablets and other mobile devices. The eMMC standard is widely used. The Agilent N6465A eMMC compliance test application helps engineers test, debug and characterize physical-layer properties of eMMC memory to ensure compliance with the JEDEC JESD84-B451 specification. The application automatically sets up the oscilloscope to trigger the right signal to run each test and generates an HTML report at the end of the test. The report compares the results with the specified test limit and indicates how closely the device passes or fails each test.

**Agilent Technologies**  
[www.agilent.com](http://www.agilent.com)

## MIMO wireless channel emulation logic subsystem

octoScope announced a real-time logic implementation of its multiple input multiple output (MIMO) octoFade wireless testing solution. When applied to a wireless signal using digital signal processing, channel emulation makes the signal appear as though it has traversed a realistic indoor or outdoor space, having been reflected from walls, cars, people or other surfaces. With octoFade, channel emulation can be integrated into

wireless test equipment such as vector signal generators (VSG) and base-station emulators. octoFade implements channel models defined by standards bodies such as IEEE 802.11 and 3GPP. These channel models emulate the effects of multipath and Doppler fading occurring in typical indoor and outdoor environments. octoFade is the first computational subsystem of a MIMO wireless channel emulator being offered stand-alone for integration into test instruments or testbeds. octoFade-3GPP is an RTL solution that implements standards-based 2G/3G/LTE channel models (802.11n/ac models to be added soon). octoFade-module is a PCIe based FPGA board running octoFade-3GPP RTL in a PC system. A powerful applications programming interface (API) lets engineers and integrators configure octoFade logic with 3GPP certification channel models. Engineers can also configure octoFade with custom channel models. octoFade-3GPP RTL and octoFade-module hardware can be easily integrated with test equipment, such as base station emulators or VSGs, thereby enabling these instruments to also serve as channel emulators, saving end-users the cost of expensive stand-alone channel emulators.

**octoScope**  
[www.octoscope.com](http://www.octoscope.com)

## High-power, battery-operated portable PIM test analyser

The PIM Master MW82119A passive intermodulation (PIM) test analyser from Anritsu is battery-operated, portable and one quarter the size and half the weight of alternative PIM test solutions according to the manufacturer.

The MW82119A offers the inherent advantages of PIM Master, including 40W testing and Anritsu's patented Distance-to-PIM (DTP) in a compact housing suited for difficult-to-access sites, such as Remote Radio Head (RRH) installations and indoor Distributed Antenna Systems (DAS). Six models are available to address major frequency ranges, including the upper and lower 700MHz bands, 850MHz, 900MHz, 1800MHz, 1900MHz, and 1900/2100MHz. All six PIM Master MW82119A analyzers incorporate DTP technology, allowing tower contractors, maintenance contractors, and wireless service provider field technicians to pinpoint the location of PIM problems, whether they are on the tower or outside the antenna system. A flexible power adjustment capability allows a single MW82119A analyzer to conduct PIM testing on low-power DAS systems, as well as high-power Macro Cells. The unit is designed to withstand transportation shock, vibration, and harsh outdoor test conditions associated with cell site deployment, installation and maintenance. Testing is simplified by the analyzer's ability to save and recall test set ups for standardized testing, and limit lines can be set for visual and/or audible pass/fail criteria. Anritsu's Line Sweep Tools can be used to manage PIM Master MW82119A measurements, and generate reports that combine VSWR data as well as PIM data into a unified site report. PIM measurements can be tagged with the GPS location when the analyzers are equipped with the GPS option.



**Anritsu**  
[www.anritsu.com](http://www.anritsu.com)

## Small-footprint milling machine improves package decapsulation workflows

Ultra Tec Manufacturing's Blue Mill Pre-Cavitation and Gasket Milling System addresses several key challenges that limit the usefulness of chemical decapsulation (acid) systems by quickly and effectively pre-cavitating 'difficult' mold compounds and other electronic packaging materials for electronic failure analysis and counterfeit prevention. Blue Mill is a small footprint (only 254mm wide) milling machine that has analogue controls for setting X-Y table amplitude, and a 5-micron accuracy Z-Axis, with digital readout. A rapid pre-cavitation process, often as short as 2-3 minutes, yields a sample with extremely straight etch-walls, ready for final decapsulation with a Chemical Decapsulator, such as Ultra Tec's own Rapidetch dual acid system, or a plasma-based (dry decapsulation) machine. Other applications of Blue Mill include the manufacture of standard fluoro-elastomer gaskets used in chemical decapsulation machines, and the machining of workholders and fixtures for decapsulation and polishing.

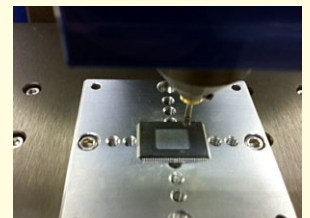

**Ultra Tec Manufacturing**  
[www.ultratecusa.com](http://www.ultratecusa.com)

### Digital power meter feature 0.1% of reading accuracy from a few mA up to 40A

Yokogawa's WT300 series of digital power meters combine accurate and reliable power measurement over a wide power range with flexibility, ease of use and a choice of communication interfaces. The new instruments will help developers and manufacturers of electrical equipment – ranging from domestic “white goods” to lighting systems and air-conditioning equipment – to ensure that their products comply with emerging IEC and EN standards and increasingly complex and stringent specifications on energy efficiency. Key features of the new instruments include a basic accuracy of 0.1% of reading, guaranteed accuracy over the entire measurement range (from 1% to 130%), a wide measurement range from standby power levels of a few mA up to the 40A currents used in induction cookers, and flexibility to enable users to target different technical and commercial applications. This includes a range of communication interfaces, allowing the WT300 series of digital power meters to be integrated into laboratory test benches or automated test set-ups on production lines. USB and GPIB or RS232 is fitted as standard, and Ethernet is available as an option. In addition to standard power measurements, the new meters offer a wide range of harmonic measurement capabilities, including the ability to carry out simultaneous measurement of normal power parameters such as RMS, mean or DC power along with measurement of harmonics up to the 50th order.

**Yokogawa**  
[www.tmi.yokogawa.com](http://www.tmi.yokogawa.com)

### Flash testing of PCBs during initial production stages

PCB manufacturers can take advantage of a fast, reliable and safe solution to meet the growing demand for flash/HIPOT tested (2kV) unpopulated boards. Electrical safety testing



specialists Clare has developed a bespoke system using its HAL104 instrument connected to a test enclosure, which enables the easy flash testing of PCBs during the initial production stages. The enclosure has a conductive foam base with modular sections to accommodate different sizes of PCBs. It can have either a spring mounted probe system or a further section of conductive foam can be added to allow it to work with different types of PCBs. Two types of PCB can be tested: those with one surface covered in metal and ‘standard’ units with an insulated side. Regardless, the track side of the PCB is placed face down on the conductive foam, enabling all metallic parts to be in contact with the foam and providing a ‘base bed’ for the remainder of the insulating surface of the board. Once in position, a flash test is then performed across the board, testing for integrity. As well as load and power functional tests, the HAL104 tester incorporates AC/DC Hipot, insulation, ground bond testing to 40A, load testing up to 20A (5kVA) with leakage measurements from 100 microAmps to 20 milliamps, with 10 microAmp resolution.

specialists Clare has developed a bespoke system using its HAL104 instrument connected to a test enclosure, which enables the easy flash testing of PCBs during the initial production stages. The enclosure has a conductive foam base with modular sections to accommodate different sizes of PCBs. It can have either a spring mounted probe system or a further section of conductive foam can be added to allow it to work with different types of PCBs. Two types of PCB can be tested: those with one surface covered in metal and ‘standard’ units with an insulated side. Regardless, the track side of the PCB is placed face down on the conductive foam, enabling all metallic parts to be in contact with the foam and providing a ‘base bed’ for the remainder of the insulating surface of the board. Once in position, a flash test is then performed across the board, testing for integrity. As well as load and power functional tests, the HAL104 tester incorporates AC/DC Hipot, insulation, ground bond testing to 40A, load testing up to 20A (5kVA) with leakage measurements from 100 microAmps to 20 milliamps, with 10 microAmp resolution.

**Seaward Electronic**  
[www.seaward.co.uk](http://www.seaward.co.uk)

### Rugged portable RF/IF signal recorder samples signals up to 500MHz

The Talon RF/IF signal recording and playback system Model RTR 2727 from Pentek is rugged portable recorder suitable for military and aerospace applications. The system features recording and playback of IF signals up to 700MHz with signal bandwidths to 200MHz. It can be configured with 500MHz 12-bit A/Ds or 400MHz 14-bit A/Ds and an 800MHz 16-bit D/A. Pentek's SystemFlow software allows turnkey operation through a graphical user interface (GUI), while the SystemFlow application programming interface (API) allows easy integration of the recording software into custom applications. At the heart of the recorder are the Pentek Cobalt Series Virtex-6 software radio boards featuring A/D and D/A converters, DDCs (digital downconverters), DUCs (digital upconverters), and FPGA IP. This architecture allows the system engineer to take full advantage of the latest technology in a turnkey solution. Optional GPS time and position stamping captures this critical signal information within the recording. The RTR 2727 has a portable, lightweight chassis with up to eight hot-swap solid state drives (SSDs), front panel USB ports and I/O connections on the side panel. Its extremely rugged 100% aluminium alloy case is reinforced with shock absorbing rubber corners and an impact-resistant protective screen. Shock- and vibration-resistant solid-state drives (SSD) with combined capacity to 3.8 TB make the RTR 2727 a reliable, portable field instrument. By using hot swappable SSDs, the recorders exhibit high immunity to shock and vibration for ground vehicles, ships and aircraft. The drive array capacity can be as large as 3.8 TB and supports RAID levels 0, 1, 5, or 6.

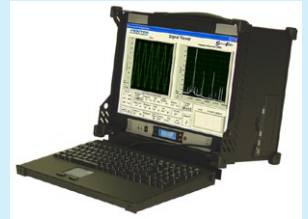

**Pentek**  
[www.pentek.com](http://www.pentek.com)

### X-ray inspection system supports printed circuit boards up to 1205x672mm

Nordson DAGE has upgraded its XD7800 Ruby XL X-ray inspection system dedicated for large area printed circuit boards, able to take a maximum board size of 1205x672mm. The X-ray inspection system also includes the unique, maintenance-free, Nordson DAGE NT500 160kV sealed-transmissive X-ray tube that provides up to 10W of target power at sub-micron feature recognition and the exclusive Nordson DAGE 2 Mpixel iDAT3 digital image intensifier detector with real time image enhancements. These features allow the system to cover all of the failure analysis and production inspection tasks that are required for large circuit board assemblies. The system can use Nordson DAGE's X-Plane analysis system option which allows X-ray inspection in any plane within the assembly, or its components, without the need to destroy these large, usually very expensive, assemblies, as would be necessary with traditional CT analysis.



**Nordson DAGE**  
[www.nordsondage.com](http://www.nordsondage.com)



## 1.2GHz OCXO reference clock for ADC and DAC applications

IQD's new IQOV-150 series OCXO satisfies the growing demand for low phase noise reference clocks for Analogue-to-Digital Conversion (ADC) and Digital-to-analogue Conversion (DAC), especially for very fast measurements and high speed data transfer. Available at frequencies up to 1.2GHz, the new design is based upon an internal high frequency OCXO combined with additional frequency multiplication and special filtering to achieve very low phase noise down to -160dBc/Hz at 100kHz. The new design is housed in an industry standard IEC C008

5-pin Euro package measuring 36x27mm and only 16mm or 19mm high depending upon specification. Frequency stability is  $\pm 0.5$ ppm (parts per million) over the operating temperature range of -20 to +60°C along with a pulling capability of  $\pm 3$ ppm minimum. Working off a supply voltage of 12 Volts, the IQOV-150 offers Sinewave output of 0 to 13dBm into 50ohms.

**IQD Frequency Products**  
[www.iqdfrequencyproducts.com](http://www.iqdfrequencyproducts.com)



## Boundary Scan software XJTAG 3.0 works faster and more intuitively

XJTAG launches version 3.0 of its industry-leading boundary scan development system, designed to work

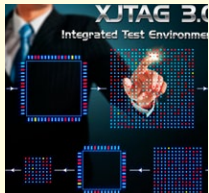

faster and more intuitively, offering the smartest testing solutions for programmers and engineers.

Crucial development tools such as XJAnalyser and XJDeveloper have been upgraded to run more effectively, maximising the opportunity for high work efficiency and productivity. Version 3.0 features run-time enhancements which boost the speed of XJEase testing and device programming in XJDeveloper and XJRunner. XJAnalyser can now be used as an integrated function in XJDeveloper as well as in its standalone form. The improvements which enable this integration make XJAnalyser more intelligent, with the result that it can now use the knowledge contained in an XJDeveloper project: netlist information, constant pin settings etc. This sets up a helpful program symbiosis previously unavailable – XJAnalyser can open XJDeveloper and XJRunner projects, while XJDeveloper can access the full functionality of XJAnalyser. In addition, the JTAG Chain Debugger is now integrated into XJDeveloper. The general functionality of the whole software package has been incorporated into one streamlined system and made easier to apply to the test and development of electronic boards, so it is now even quicker for engineers to understand and implement.

**XJTAG**  
[www.xjtag.com](http://www.xjtag.com)

## Efficient POWER SOLUTIONS from the wall to the point of load™

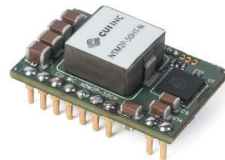
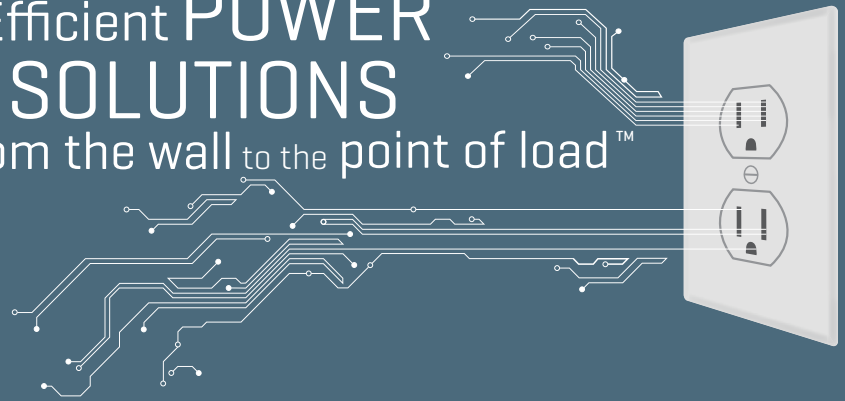

10 W~468 W

Digital Power Modules  
 Intermediate Bus | Point of Load



0.25 W~600 W

Dc-Dc Converters  
 Board Mount | Chassis Mount



1 W~2400 W

Ac-Dc Power Supplies  
 Open Frame | Chassis Mount | External

With a continuous focus on *efficiency, density, and system optimization*, we keep our customers on the *leading-edge* of the power curve.



# Readying copper cable technicians to install optical fibres

By Andy Cole

**THE RATE AT WHICH** fibre-to-the-home and fibre-to-the-office are being installed is accelerating dramatically. Attracted by the opportunity to take a share of valuable media markets such as video-on-demand and video telephony, European telecoms network owners are extending the reach of their optical fibre networks from the core to the access network in order to offer homes and small businesses broadband connections of 100Mb/s or faster.

As optical fibre begins to reach the 'last mile' from exchange to premises, the existing cable installation workforce, trained and experienced in the installation of copper connections, faces the challenge of mastering new technology and a new physical medium. The skills, practices, habits and knowledge which have served telecoms installers well in the copper era need to be replaced by new skills in the fibre optic age.

So what are the main differences installers must take account of when working with fibre for the first time? And how can modern instruments make the transition easier?

## Optical fibre's mechanical properties

Metal cables can be installed by pulling them into ducts and conduits: the cable is physically robust enough to withstand the traction and torsion forces applied to it. Copper cable can also be bent around corners with a tight radius to present a neat installation. So long as lengths of metallic cable are physically joined, continuity of the electrical path is maintained. Joints can be soldered, twisted, crimped, or fastened with a screw: as long as they are made to a reasonable standard, the electrical connection should perform without trouble for many years.

Optical fibre, on the other hand, must be handled with great care. It will not withstand the same mechanical stresses as copper cable, and is more easily damaged. In addition, the optimal direction of travel of light is in a straight line: while bends of a limited radius are allowable, too tight a radius will dramatically reduce or even block the passage of light. Dirt and contaminants, which have very little effect on copper cable, can also seriously compromise the performance of optical fibre. Even a very small amount of dirt in a fibre joint can result in high losses, and seriously impair its ability to transmit light.

This means that the pre-requisites of a successful fibre installation are:

- The use of high-quality components
- The use of high-quality tooling (such as a fibre optic splicer)
- The implementation of good working practices
- To verify whether an installation has in fact been successful, the installer needs to test the cable. Here again, there are significant differences between the test practices required for copper and those required for fibre.

Andy Cole is Field Applications Engineer at Anritsu (UK) - [www.anritsu.com](http://www.anritsu.com)

But installation professionals with no special expertise in fibre may be helped considerably by the test automation capabilities of the latest instruments.

## What does an OTDR do?

The modern Optical Time Domain Reflectometer (OTDR) performs the majority of fibre optic measurements required today. It is used in the commissioning process, to verify a new installation, and to identify and locate faults in existing installations. Indeed, a trace from a handheld installation tester such as the Access Master OTDR or the Network Master  $\mu$ OTDR from Anritsu will form the basis of the commissioning report submitted to a network owner as proof that an installation has been completed correctly – a requirement for contractors to secure payment for their work.

The benefit of using a modern OTDR is that it will take measurements automatically, relieving the user of the burden of designing, configuring and implementing test routines. This is perfect when measurement results are required quickly, or when the user is not experienced in the use of an OTDR.

Indeed, an OTDR with automatic measurement capability can drastically reduce the need for time-consuming and costly training for copper cable installers who are making the transition to fibre installation. For more experienced OTDR users, these instruments will still provide full flexibility to set the parameters and the display manually as required.

With a single measurement ('trace'), the OTDR provides a complete picture of the fibre installation. It measures and displays the length of the cable, the total loss over this length, the loss across spliced joints, the insertion loss of connectors and other components such as splitters used in Passive Optical Networks (PONs), and the return loss.

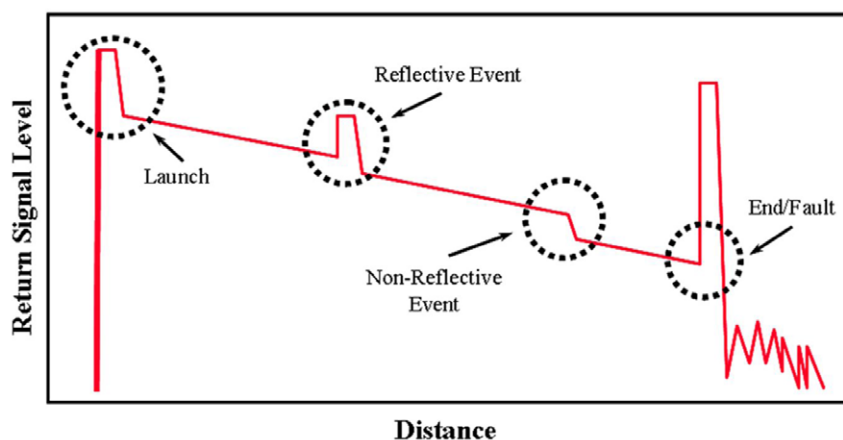

Fig. 1: a simplified rendering of an OTDR trace showing the typical shape of reflective and non-reflective events.

The OTDR also identifies events, such as connector joints, spliced joints, and splitters used in PONs, in an easily read table. This verifies that an installation is within its allowable limits for each parameter, and alerts the user to any events for

# THE ORIGINAL PUSH-PULL CONNECTOR

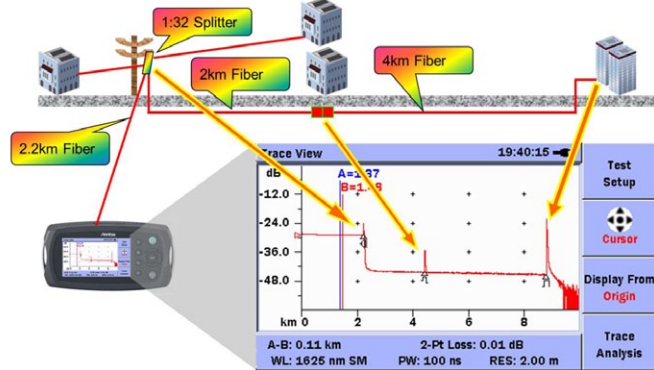

Fig. 2: Trace from a PON installation with a single splitter.

which specified limits are exceeded in any parameter.

Finally, the OTDR will identify problems which, while not sufficient to cause failure immediately, could result in performance impairment or complete failure in future. Such problems include excessive bends (macro bends), and other mechanical stresses in the fibre installation.

## How does an OTDR work?

The OTDR sends a pulse of light at a precise wavelength through the fibre under test. Along the length of the fibre, minute particles embedded in the glass during its manufacture cause a small amount of light to be scattered. Some of this scattered light travels back to the OTDR; this is known as backscatter. The OTDR includes an extremely accurate light sensor which can measure precisely the amount of light returning to it as backscatter, and also measure the time between emitting a pulse and receiving the backscatter from that pulse.

The glass used to manufacture optical fibre is extremely pure, and these particles are evenly spaced and scatter light uniformly. Information about the regular backscatter behaviour of manufactured fibre (before it is installed) is provided by the manufacturer and programmed into the OTDR. The OTDR then compares the backscatter it measures in an installed fibre under test with the backscatter that it expects from the manufacturer's data in order to calculate an optical loss figure; and also to locate the cause(s) of losses along the length of fibre under test, through a calculation using the elapsed time between a pulse and its associated backscatter, and the speed of light.

A simplified version of an OTDR trace is given in figure 1,

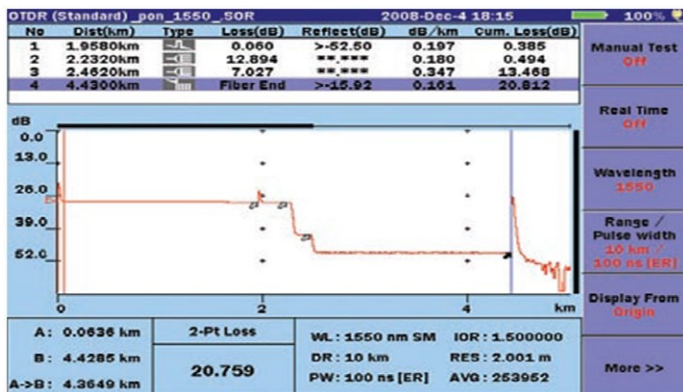

Fig. 3: Trace from a PON installation with two closely cascaded splitters, showing the event table at the top of the display.

## More than 50'000 connector combinations

The modular design of LEMO products provides more than 50'000 different combinations of connectors with a large choice of contact configurations:

- High and low voltage
- Coaxial and triaxial
- Quadrax
- Thermocouple
- Fibre optic
- Fluidic and pneumatic
- Hybrid
- Custom solutions
- Cable assembly



LEMO SA - Switzerland

Phone: (+41 21) 695 16 00  
Fax: (+41 21) 695 16 02  
info@lemo.com



Contact your local partner on [www.lemo.com](http://www.lemo.com)

showing some events found in a typical fibre measurement. Some events such as splice joints reflect no more light towards the OTDR than the fibre itself does. They follow the trend line of the trace, which shows a gradual decrease in reflected light over the length of the fibre. These are known as non-reflective events.

Other physical events, such as connector joints, cracks in the fibre and the fibre end, cause a greater level of light to be reflected to the OTDR and are known as reflective events. The higher level of light returned to the OTDR from reflective events momentarily saturates the OTDR's sensor to a level above the backscattered light that follows it, and the sensor needs to recover before it can see beyond the reflective event. The distance it takes for the OTDR to recover is known as the dead zone.

To be more precise, dead zones can be characterised in one of two ways: a reflective/Fresnel dead zone is the distance it takes for the OTDR to be able to see the next reflective event; an attenuation dead zone is the distance it takes for the OTDR sensor to recover to a level at which it can correctly measure backscatter. In a high-quality OTDR, dead zones are very short.

In addition, fast growth in the deployment of PONs, which use multiple levels of splitters in the network architecture, adds further complexity, and requires a more complex calculation to correctly measure loss. When the opti-

| No. of Splits | Associated Loss |
|---------------|-----------------|
| 1 x 2         | 3dB             |
| 1 x 4         | 6dB             |
| 1 x 8         | 9dB             |
| 1 x 16        | 12dB            |
| 1 x 32        | 15dB            |
| 1 x 64        | 18dB            |
| 1 x 128       | 21dB            |

Table 1: how fibre splits lose light in PONs.

cal path is split from one into multiple fibres, the power of the light is distributed to each corresponding fibre. This represents a loss of light in each fibre and equates to 3dB each time the number of splits doubles ( $1 \times 2 = 3\text{dB loss} = \text{power halved}$  – see Table 1).

As a PON branches out across the region it serves, more and more splitters are used, and sometimes they can be so closely spaced that they become difficult for a conventional OTDR to measure. Anritsu's OTDRs for PON installations are able to identify closely spaced splitters using short pulse widths, resulting in high measurement resolution and accuracy, ensuring that the user can see all events in the network - see figures 3 and 4.

Since these measurements on a PON are fully automated and take account automatically of the number of splits, there is no need to train the fibre installer in complex PON network architectures in order to produce valid test results. A modern

OTDR will also provide other features which help the inexperienced user test fibre installations effectively. These include an optical power meter and optical loss test sets. In addition, a Visible Laser Diode (VLD) can be used to help find pinpoint breaks in the fibre, and a Video Inspection Probe (VIP) can be used to view and save a 400x magnified image of the fibre end face. Many network owners now require installers to supply an image of the fibre end to prove that all fibre connections are clean on installation.

## The advantages of hyperboloid contact technology

By Bill Henderson

Hypertac has been well known in the aerospace, rail and industrial markets as the company that provides the blue printed circuit board connectors incorporating the hyperboloid socket contact technology. What perhaps is less widely known is that Hypertac also provides the very high performance rack and panel connectors for applications such as avionics suite of the Eurofighter aircraft, as well as the heavy duty transponders for the rail Eurobalise system. This relies on the superior fretting corrosion resistance which is a unique characteristic of the hyperboloid socket contact to maintain reliable operational performance during missions. Combined with the filtering and transient protection technology within these connectors, this places Hypertac at the technology forefront within mil/aero, rail and industrial markets.

The Hyperboloid socket contact is a marvel of modern engineering where the basic socket technology can now be scaled from as small as 0.3mm diameter contacts used in very high frequency coaxial applications up to 40GHz to 30mm diameter



Fig. 1: The hyperboloid socket contact.

for very high power applications of up to 1000A. The basic construction of the Hyperboloid socket contact is shown in figure 1. The fundamental characteristics available from this design are retained across the whole range and offer substantial advantages over the more standard bifurcated socket contact design. Furthermore, the socket contact design offers a tremendous opportunity for characteristic optimisation to suit particular applications. For example, the diameter and number of wires used within the hyperboloid cage together with the length of contact and the angle of twist can all be varied to optimise insertion

Bill Henderson is Industry Director, Aerospace and Defence at Hypertac - [www.hypertac.com](http://www.hypertac.com)

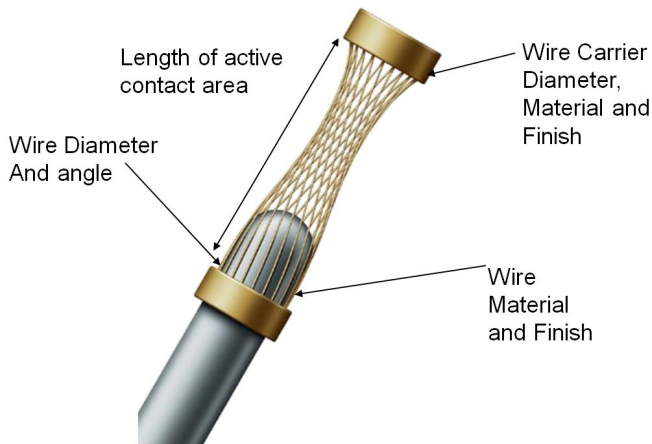

Fig. 2: Design parameters of the hyperboloid socket contact

force, mating cycle, fretting corrosion resistance, and power handling - see figure 2. In addition, the choice of wire material and plating finish can also be optimised for each application such as high temperature or high frequency requirements. The fretting corrosion characteristic of this socket contact, vital for reliable operation on-board Eurofighter, compared with more traditional fork and blade contacts is shown in figure 3.

Of course, the socket contact alone does not make a connector and today this technology has been incorporated within a wide variety of standard and custom connector shells to suit all applications. A recent challenge was to determine whether this socket configuration would be suitable to pass high Radio Frequency signals commonly found in airborne radar systems. RF signals are transmitted along coaxial cables of a defined characteristic impedance and any significant change in this characteristic along the transmission path results in energy being reflected back towards the transmitter. Multiple changes can result in multiple reflections and a substantial degradation in the overall system performance. The challenges were therefore two-fold: first to design a contact with a tightly-controlled characteristic impedance and excellent radio frequency transmission characteristics and second, to design this contact small enough for the airborne radar application and in keeping with coaxial cable diameters. These challenges resulted in the Hyperboloid once again proving its outstanding capabilities demonstrating insertion loss and VSWR characteristics up to 26GHz and beyond - see figure 4. This high frequency capability also allows high speed data to be transmitted at frequencies in excess of 5Gbps and a range of Micro Twinax and Quadrax connectors are currently under development.

FRETTING. 50Hz, 1mm amplitude.

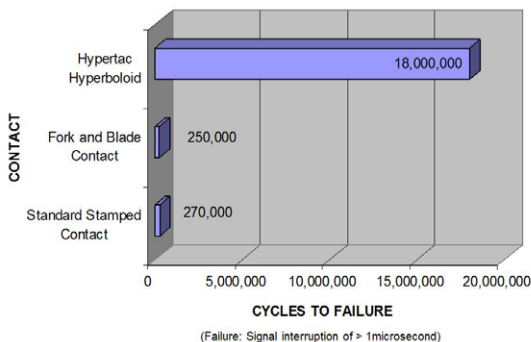

Fig. 3: Fretting corrosion characteristic of hyperboloid contacts.

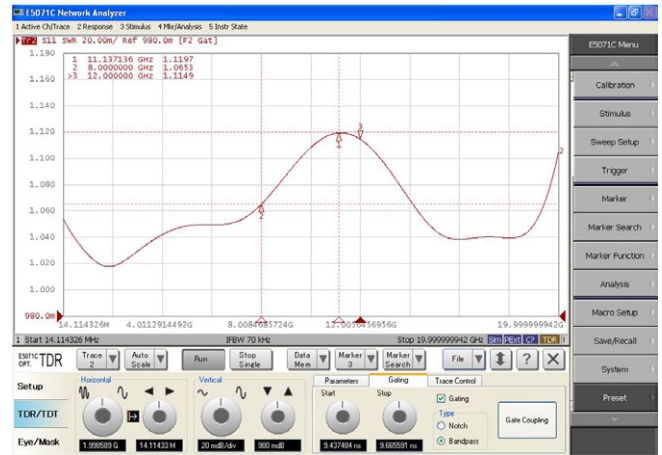



Fig. 4: VSWR for a mated pair with Hypertac coaxial sockets for both inner and outer contacts.

The market waits for no-one however, and even before the first of these platform products can be launched, customers are already requesting custom connectors fitted with this type of contact for their own applications.

Of course the availability of the technology is not the only reason why more customers are turning towards the Hyperboloid solution and Hypertac has invested substantially in the ability to turn around custom solutions quickly. This approach allows the customer to optimise the connector for his application providing the best possible performance of his system in the smallest space within a cost effective framework.

# 5707

## Safe power entry for medical applications



V-Lock



Strong in Design and Safety

- Medical fuse holder and mains filter
- IP 65 protection to the appliance
- V-Lock cord retaining

www.schurter.com/emc\_news

SCHURTER

ELECTRONIC COMPONENTS

### Power connector handles currents up to 16A and voltages up to 600V

Souriau's UTL is a power connector intended for outdoor applications such as architectural and urban lighting, portable power tools and telecom relays. It conforms to the latest UL and IEC standards, and can handle currents up to 16 A and voltages up to 600 V. UTL is compatible with the latest Underwriters Laboratories (UL) and International Electrotechnical Commission (IEC) standards applicable to luminaires (UL 1598, IEC 60598), telecom relays and portable power tools. The high breaking capacity connector features a design that makes it very difficult to access live parts. Closed by a patented latch system which secures the connector, UTL features IP68/69K rated ingress protection. The cables in the male connector are molded into the connector, allowing them to be configured straight or at 90° without compromising connection quality or sealing. Even if the cable sheath is cracked, no liquid can enter, as the cables are encapsulated in the molding. Special sealed contacts can also be supplied. With its IPX8 rating, UTL can also be submerged for a week at a depth of 10 meters when coupled, and the sealed-contact version for a week at a depth of 1 metre when uncoupled. UTL is proven for 500 mating cycles and withstands vibrations according to standard IEC 60512-4 from 10 to 2000 Hz. It can be used at temperatures from -40 to +105 °C, conforms to smoke and fire control standards, and withstands saline spray for more than 1000 hours.

Souriau

[www.souriau-industrial.com](http://www.souriau-industrial.com)

### Single-piece, bottom entry, card edge connector for LED bulb assemblies

AVX has developed a high-performance, bottom entry, board-to-board, card edge connector system designed for use in Edison-replacement LED bulb assemblies. The 9159-



500 surface mount, bottom entry, card edge connector allows a perpendicular PCB to be mated to a top-mounted main FR4 or metal core PCB from the bottom side using standard pick and place equipment and reflow soldering.

The 9159-500 connector is available in a range of 2-6 positions, which allows for increased functionality in application designs, such as color control or specific line control. For example, white bulbs only require two connections, while architectural bulbs require two connections for power and ground in addition to four control lines to support red, green, blue, and white coloring. Featuring dual PCB slot widths, the bottom entry, card edge connector is also compatible with both 0.8mm and 1.6mm PCBs, which provides design engineers with increased flexibility regarding PCB layout and selection. Rated for 10 mating cycles, 2A per contact, 250VAC/DC, and use in temperatures ranging from -40°C to +120°C, the 2mm pitch connector provides high performance in a compact design. Featuring gold-plated beryllium-copper (BeCu) spring contacts, the connector also provides long-term reliability.

AVX

[www.avx.com](http://www.avx.com)

### IP67 rated compact module with M12 connectors

HMS Industrial Networks has released a series of Anybus CompactCom modules equipped with M12 connectors. This enables network connectivity for machinery which operates in wet, dusty, or otherwise demanding industrial environments. Networks are initially PROFIBUS, PROFINET, DeviceNet, EtherNet/IP, Modbus TCP and EtherCAT. Just as the standard CompactCom modules, the new M12 versions will be available with and without housing. The M12 version without housing makes it possible to achieve a protection rating of IP67 (IP = Ingress Protection). This means that the product is completely sealed from dust and can resist water. The CompactCom M12 versions with housing are IP20 rated, just as the standard CompactCom modules with the default fieldbus connectors. The Anybus CompactCom modules with M12 connectors offer the same functionality as standard CompactCom modules, including complete interchangeability between modules. This means that once the Anybus CompactCom concept is implemented into a product, it is possible to just plug in any CompactCom module to get access to the targeted network.



HMS Industrial Networks

[www.hms.se](http://www.hms.se)

### Terminal post connections for audio, power and instrumentation

The flexible terminal post connection systems from Cliff Electronics include single terminal binding posts and multiple binding post assemblies in a number of different designs and configurations for consumer and professional applications. Rated up to 60A, the binding posts are also available in fully insulated, touch-proof and 4mm versions for test and instrumentation applications, with solid brass, gold-plated models for use in Hi-Fi speaker applications also available. Cliff manufactures dual binding post assemblies in a variety of designs in either standard or custom configurations. The company also manufactures the BFA (Built For Audio) range of terminals, which have been designed in response to European industry safety requirements prohibiting the use of banana plugs in order to minimise the risk of accidental electric shock. In the BFA range the customary 4mm socket is replaced by a 4mm spring contact probe and 3.6mm cross holes for wire connection prevent the entry of banana plugs, meeting the norms of BS EN 60065 for audio applications. Key specifications include nickel and gold-plated finishes, 4mm plug, fast-on or cable connection with blanking buttons available to ensure touch-proof safety properties. Pre-assembled horizontal and vertical PCB-mounting terminal plates are available as are anti-magnetic nickel free versions for industrial applications and custom binding post designs are regularly undertaken for specific applications.



Cliff Electronics

[www.cliffuk.co.uk](http://www.cliffuk.co.uk)

## Wash-down actuator/sensor cordsets operational from -40 to +105°C

Belden has added new wash-down connectors to its Lumberg Automation product program in the EMEA region. Optionally available as single-ended or double-ended actuator/sensor cordsets, these connectors come with an M8 or M12 thread and a hexagonal stainless steel coupling nut. Resistant to aggressive chemicals and cleaning agents, these new connectors have an operating temperature range of -40 to +105 °C. They also satisfy the IP67, IP68 and IP69K requirements for ingress protection. As a result they can be high-pressure cleaned, and are therefore ideally suited for use in areas where stringent rules of hygiene apply, e.g. in the food and beverage sector, chemical and pharmaceutical industries. Other features include gold-plated crimp contacts, high shock- and vibration resistance, and simple installation. The Wash-down connectors guarantee reliable data transmission even under harsh environmental conditions, thus helping to maintain a high productivity level of equipment. Connectors are available in 3-, 4-, 5-, or 8-pole versions (M8 3 or 4 poles) with a contact resistance under 5 mΩ. Nominal current, rated voltage and rated impulse voltage are in accordance to DIN EN 61076-2-101 and DIN EN 61076-2-104. Insulation resistance is over 109 Ω. Available in a cream-white color, the connectors' compact housings are made of polypropylene (PP).



As a result they can be high-pressure cleaned, and are therefore ideally suited for use in areas where stringent rules of hygiene apply, e.g. in the food and beverage sector, chemical and pharmaceutical industries. Other features include gold-plated crimp contacts, high shock- and vibration resistance, and simple installation. The Wash-down connectors guarantee reliable data transmission even under harsh environmental conditions, thus helping to maintain a high productivity level of equipment. Connectors are available in 3-, 4-, 5-, or 8-pole versions (M8 3 or 4 poles) with a contact resistance under 5 mΩ. Nominal current, rated voltage and rated impulse voltage are in accordance to DIN EN 61076-2-101 and DIN EN 61076-2-104. Insulation resistance is over 109 Ω. Available in a cream-white color, the connectors' compact housings are made of polypropylene (PP).

**Belden**  
[www.belden.com](http://www.belden.com)

## Flexible battery-connector solution with cable connection

For all applications that require a separable, miniaturized, safe, reliable and particularly flexible connection between electronic equipment and a battery, Suyin now offers an ultra-low-profile battery plug-and-socket combination that can be varied to meet customer-specific needs. With this solution, the 060087GS four-position plug can be placed at any suitable position on the board and mounted using through-hole technology (THT), and the 060088HS

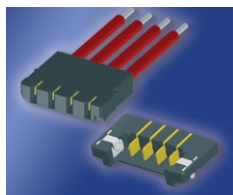

socket is equipped with a flexible cable that can be adapted to match nearly any customer requirements by varying the length along with all other specifications (cross section, color, shielding, etc.). The compact overall dimensions for the female connector (without the cable) and male connector when mated are 12.6x8.75x2mm. The long-lasting blade contacts with a pitch of 1.8 mm can conduct 12 VDC / 5 A per pin, and the high level of mating reliability is tested at the factory at 500 +/- 50 mating cycles per hour. Other key technical characteristics that this completely halogen-free battery connector solution offers include the extremely low contact resistance of 30 mΩ (initial), the excellent insulation resistance of 1000 MΩ as well as the wide range of operating temperatures, which extends from -40 to +105 °C.

**Suyin**  
[www.suyin-europe.com](http://www.suyin-europe.com)

## M12 connectors comprise 3, 4, 5 and 8 way contact positions in a compact design

Hypertac has introduced a new range of M12 style connectors comprising 3, 4, 5 and 8 way contact positions; options for over-moulded or free assembly and straight or 90 degree versions to meet all the recognized standards and industry norms. A floating female hyperboloid crimp socket within a robust connector insulator and shell provides the benefit of this anti-vibration arrangement which ensures



a safe and secure connection for all signals. Insulator assembly within the connector is simplified with a simple touch, look and feel system to ensure correct orientation. An identical, highly compact form factor for each version is another advantage, providing the highest possible connector to connector density. For the free-assembled right-angle version, an adaptable cable entry termination allows for a change to a straight version in the field without compromising the IP67 reliability. The stamped hyperboloid 0.8mm (8way) and 1.0mm (3/4/5way) contact used within the M12 system supports wire diameters of 0.03mm to 0.5mm (AWG32 to 20), and is suitable for automatic high-speed crimping systems, providing further benefits of process stability and repeatability. The 1.0mm machined contact variant also offered in the 3, 4 and 5 way supports a wide range of wire diameters, from 0.05mm to 1.00mm (AWG30 to AWG18). A 1.00mm contact suitable for a cable diameter of 10mm is also available to customers. All D-coded 4-way and A-coded 4 and 5 way arrangements have a 360 degree screen termination, which provide complete protection and shielding against EMI/EMC when coupled with the all-metal shell.

**Hypertac**  
[www.hypertac.com](http://www.hypertac.com)

## 1-row horizontal design socket connector with a 1.27mm pitch

The 1.27 mm pitch socket connector series from Fisher Elektronik, "BLM" has been upgraded into a 1-row horizontal design. As in the case of the entire BLM series, BLM SMD 3 is suitable for the pin header SLV (0.4 mm square) or SLM (0.3 mm square). It is available in pole numbers from 2 to 20. The fork contacts of the BLM 3 SMD are refined with gold or tin (pure tin) on the surface and are accordingly available as socket connectors as well. The contact material of the socket connector is made of a CuSn alloy. Safe operation is guaranteed within a temperature range of -40 to +163°C. As with the previous design, the insulating body is made of a high temperature-resistant plastic (flammability class: UL94 V-0), thus making the socket connector suitable for the lead-free, reflow soldering method. The materials used comply with EU Directive 2002/95/EC (RoHS) and the requirements of Regulation (EC) No. 1907/2006 (REACH).

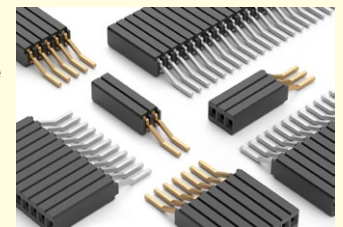

**Fisher Elektronik**  
[www.fischerelektronik.de](http://www.fischerelektronik.de)

## Identifying UHF RFID tag design weaknesses

By Myriam Massei

**UHF RFID TAGS** put on the market should all be compliant with the standard EPC gen 2. Nevertheless the performances can be very different from one tag to another. As an example, NRFLab did a benchmark of several tags which resulted in noticeable tag performance differences. The lower performances of a tag can either restrict its use at shorter distances from a reader or require the use of a high quality detection and correction tag reader.

After reviewing various tags and reader architectures, we'll use the tags' performance results obtained through testing and offer some solutions to improve the poor-performing tags.

### RFID tag design weaknesses

A typical RFID tag includes an antenna, a front end radio and a digital cell as shown on the tag's architecture of figure 1. The front-end radio – see figure 2 - is composed of a power rectifier followed by a regulator, a very simplified clock reference, a demodulator block receiver and a load modulation transmitter as detailed on figure 3.

The front-end radio architecture of an RFID tag reader is much more complex and includes an antenna, a regulated power supply, a synthesiser calibrated to generate the RF carrier using an external clock reference, a heterodyne RF receiver and a polar modulation RF transmitter – see figure 4. The cost and time development of a reader is thus much more important than for a tag.

### Why are the two architectures so different and how does it impact performance?

Usually, the RFID tag's front-end radio design is simplified as much as possible to reduce its development cost and chip size. As an example the transmit signal generated by the load modulation transmitter is not a pure real load variation or a pure imaginary load variation. The load varies over frequency. As a result the reader's architecture must be able to detect and demodulate a real and/or imaginary load variation. Secondly, the demodulation receiver is nonlinear.

It only generates a 1-bit signal (1/0) for the digital block. Additionally, the UHF RFID tag is passive which means that the power supply of the tag needs to be generated internally, using

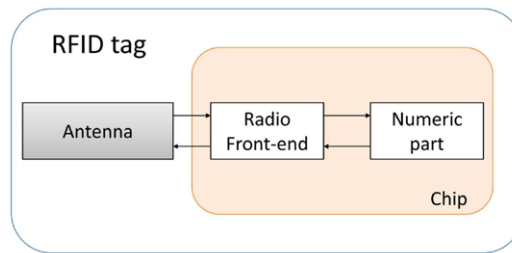

Fig. 1: Basic RFID tag architecture.

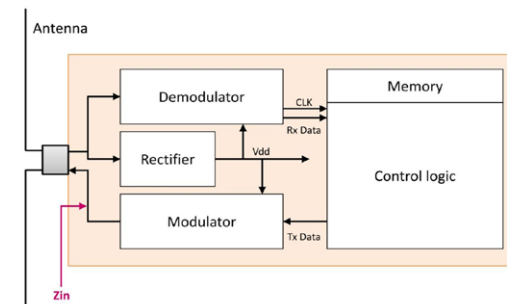

Fig. 2: RFID tag front-end architecture.

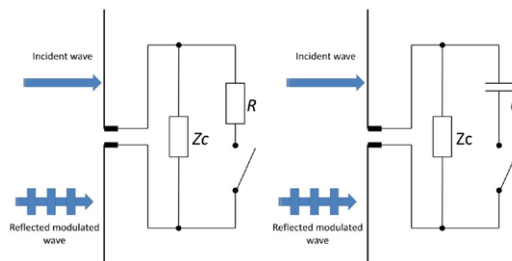

Fig. 3: RFID tag transmitter architecture (charge modulation).

the RF carrier energy down converted into a DC voltage ( $V_{dd}$ ). To implement this function the designer commonly uses a rectifier together with a regulator block. The consequence is that the power supply will vary over temperature, RF frequency range and input power (more than 30%). Overall, this means that the tag is not designed to guarantee a robust performance.

For example the clock reference that will define the precision of the backscatter link frequency (BLF) and the total length of a binary ( $T_{ari}$ ) is composed mostly by 3 or 5 inverters looped back. This architecture is very sensitive to the power supply, the temperature and process. The tag's response signal will depend on a non-robust load variation, with a non-predictable time response and at least with a very low level signal, at least compared to the input signal generated by the reader. To compensate those imperfections at tag level, the design constraints will be on the reader's architecture.

First, the reader architecture must be able to detect small signal response in a non-predictable delay and non-constant RF response type: module and/or phase (or I/Q signal). That's why a homodyne receiver structure is used. And the first stage receiver is composed of a Low Noise Amplifier to amplified

small RF signal without amplifying the noise. Secondly, the reader provides the RF carrier signal during all the communication, whether it's reader to tag or tag to reader. It needs a robust synthesizer architecture using an external quartz to generate the RF carrier. Thirdly, during the transmission (reader/ tag) the reader generates and modulates the RF carrier. During signal reception (tag to reader), the reader still generates the RF carrier and measures the signal response modulated by the tag. As the tag's receiver is nonlinear, the modulated signal transmitted by the reader to the tag can be nonlinear, but the power level must be very high (more than 16dBm). The transmitter architecture often chosen for its best efficiency and low linearity is a polar modulation structure.

### Bench mark analysis

Based on the benchmark results shown on graph 1 and 2 for nine RFID tags put under test, we have chosen two tags with different performances, namely the tags 9 and 7.

Thanks to additional tests and performances analysis (obtained through the NRFLAB test platform for UHF RFID Tags)

Myriam Massei is CEO and designer at NRFLab - [www.nrflab.com](http://www.nrflab.com) - She can be reached at [massei.myriam@nrflab.com](mailto:massei.myriam@nrflab.com)



we are able to propose some design improvements to increase the tag's performances.

### Set up test bench

The setup test bench – see figure 5 – is composed of a PC (used to proceed the query then record the tag's response demodulated and verify this is an RN16 response - 16-bit random number), an RF signal generator combined with a modulator I/Q low frequency, a circulator to transmit the signal to the antenna (Laird Technologies S8658W-P12SMM) and at least a spectrum analyser used to measure and down convert the signal response from the tag.

The distance between the antenna and the tag is 60 cm. The « query » signal is generated using the following parameters: modulation FM0 - BLF= 180 kHz - Tari=25 us. The signal generator RF is used from 800MHz to 1000MHz, with an output power from 0dBm to 16dBm. Our measurements yielded the minimum and maximum frequency range within which we could detect a RN16 response as shown on graph 1 and the minimum input power needed to detect a RN16 response over the 860-960MHz frequency range as shown on graph 2.

Graph 3 illustrates the measured average modulation depth in % detected on the RN16 response over the working frequency range. We name “modulation depth” the ratio:  $[\Delta A / A * 100]$  average of the signal response versus the reader signal transmitted – see graph 3.

### Data results analysis

Overall, 15 tags were tested using the test bench described above. Among the 15 tags, only nine gave us a RN16 response. The nine valid tags can be put into two categories as shown in table 1. From these measurements, it comes out that tag 9 presents the best performances. It works across all the frequency range of the EPC standard, its modulation depth of

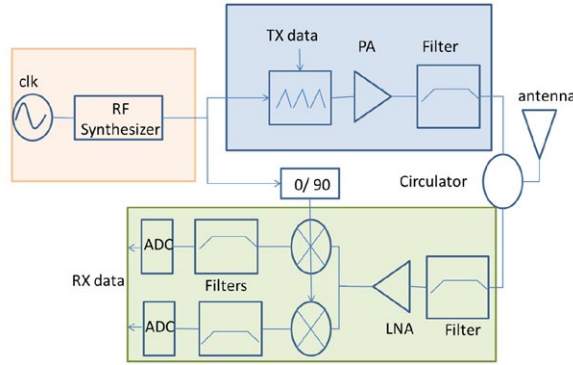
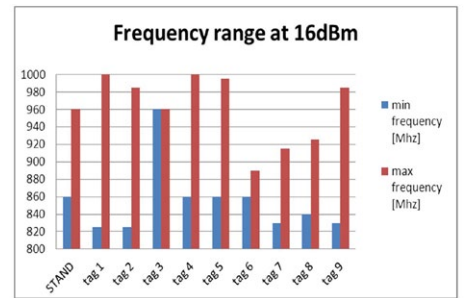

Fig. 4: RFID tag reader architecture.



Graph 1: Benchmark results - frequency range.

3.6% is one of the best among all the tags tested and the minimum power to detect an RN16 response (wake up power) is 8dBm. Tag 7 presents lesser performances. This tag only works from 820 to 910MHz.

The modulation depth of only 1% is very small which means the reader will need to be very sensitive. The minimum power to detect a RN16 response (wake up power) is 11dBm.

### Identifying and solving the issues

Why doesn't tag 7 work within the proper frequency range? Graphs 4 and 5 show the minimum power applied to detect an RN16 between 825 and 985MHz for tags 7 and 9, respectively. Tag 9 works from 830 to 985MHz while tag 7 is able to answer but only for a smaller range of 830 to 915MHz.

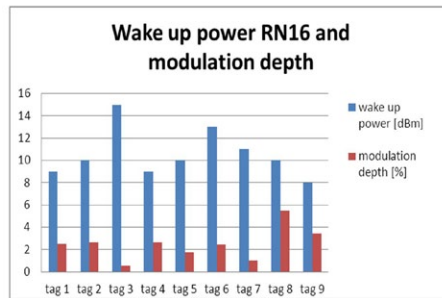

Graph 2: Benchmark results – wake-up power and modulation depth.

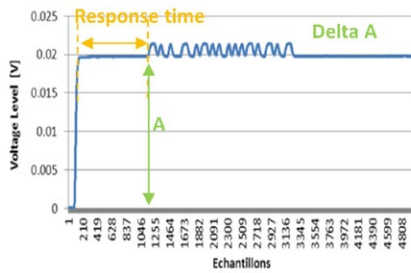

Graph 3: Set up RN16 response versus frequency and power.

The tag's response over frequency depends on the matching antenna with the combined input stage of the receiver, rectifier and transmitter of the tag. The antenna from tag 7 should be re-centred to 910MHz instead of 845MHz to cover the proper

| Good (respects the standard)      | Non-compliant to the standard  |
|-----------------------------------|--|
| Tag 1, tag 2, tag 4, tag 5, tag 9 | Tag 3, tag 6, tag 7, tag 8, Tag 10, tag 11, tag 12, tag 13, tag 14, tag 15 |

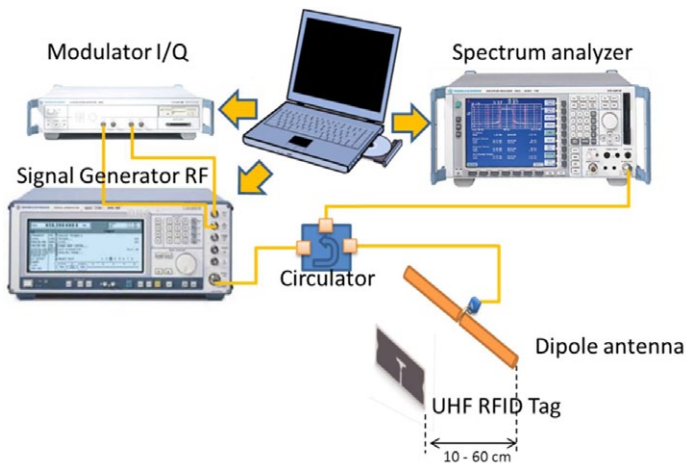

Fig. 5: Set up RN16 response versus frequency and power.

# sonitron®

Piezo audio components

B buzzers Transducers Alarms  
Sirens Piezo Speakers Amplifiers

www.sonitron.be

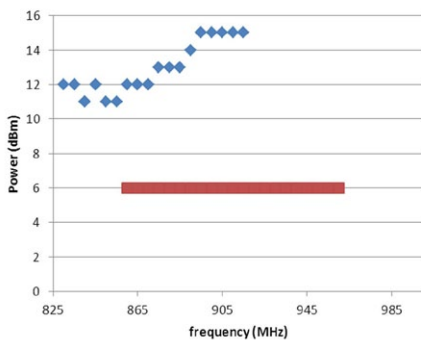

**Graph 4: Tag 9 minimum power response versus frequency to get a correct RN16 response.** frequency range standard 860 to 960MHz. Graphs 6 and 7 show the modulation depth versus frequency for tags 7 and 9, respectively.

One can see that tag 9 presents the best modulation depth at 880MHz. In other words, at 880MHz the transmitter load presents a load real: short / open.

Looking at the shape of the modulation depth, we can say that the associated transmitter load is like an LC resonator. At 880MHz the load is real, around it the load is real and imaginary. Tag 7 presents the same behaviour, centred at 890MHz.

Its peak modulation depth is smaller. In that case, the switch in tag 7 used to connect or disconnect the inductor L is too resistive.

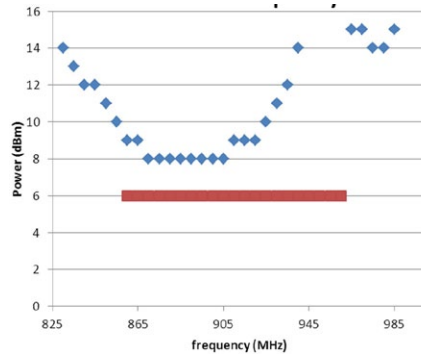

**Graph 5: Tag 9 minimum power response versus frequency to get a correct RN16 response.**

**Graph 7: Tag 7 modulation depth versus frequency.**

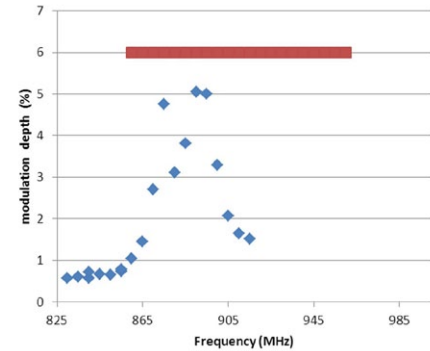

**Graph 6: Tag 9 modulation depth versus frequency.**

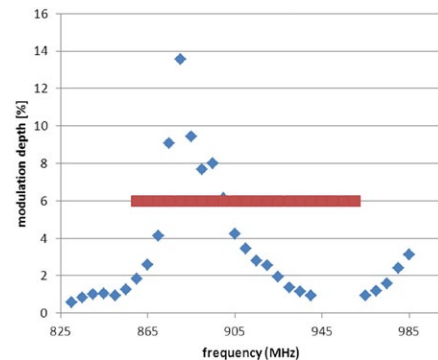

## Active RFID systems that combine robust RF performance and low power consumption

By Shawn Rezaei

**RADIO FREQUENCY IDENTIFICATION (RFID)**, as an automatic wireless data collection technology, is commonly used in applications such as asset tracking, access control and inventory management. The common way to implement the technology is in the form of passive RFID systems, in which an RFID reader transmits a modulated RF signal to RFID tags each consisting of an antenna and an IC. The chip receives power from the antenna and responds by varying its input impedance, and thus modulating the backscattered signal. The ability to backscatter is strongly dependent on the surface on which the tag is mounted. A conductive material close to the tag can adversely affect performance by detuning the tag and limiting the read range.

As a result, passive RFID systems have limitations due to any one or more of the following factors:

Tag power is limited (the power at the tag determines its read range). Tag reflection affects the signal that is scattered back. Surface on which the tag is mounted affects performance. Environmental factors can include multi-path fading and interfering readers. Above a certain speed, moving tagged objects cannot be interrogated by a reader. There is mutual coupling between tags. Performance degradation can be due to low reader Transmit antenna gain and low reader Receive sensitivity. Some systems have the inability to transmit through metal, rock,

masonry or liquid. Sometimes, wrongly oriented tags will limit readability.

Under these conditions, an 'active RFID' system, in which each active tag carries its own battery power source, offers far more robust communications performance. The battery power source enables the tag to support high-power transmission, providing for greater range, and the ability to connect even through solid barriers of metal or masonry.

But this very property of an active tag is also its main limitation: high-power UHF transmitters are power-hungry devices. So how can an active RFID system be designed to provide excellent communications performance while operating for several years on a cheap, small battery?

This article describes the operation of an active tag RFID system, and then introduces a reference design which demonstrates a way to square the circle of high RF output power and low system power consumption.

### The operation of active RFID systems

Active RFID usually operates at 455MHz, 850MHz, 900MHz, 2.4GHz or 5.8GHz. It is suited to applications such as asset and people tracking, access control, passive keyless entry in cars, parking management systems and temperature monitoring. As stated above, active RFID tags have greater transmission power than passive tags. Another difference in active RFID systems is that an active tag using its own battery power source can

Shawn Rezaei is Field Application Engineer (US) at ams - [www.ams.com](http://www.ams.com)

continually transmit its identity and other data at a pre-determined rate back to the reader or a base station – tags are typically configured with an interval of around one or two seconds between transmissions. This gives the system designer considerable extra flexibility compared to a passive RFID system, in which the passive tag must first receive a transmission from a reader before it can initiate a data transmission. In an active RFID system, by contrast, a tag can broadcast its identity to a reader over a relatively long range (up to 100m) even if the tag's receive path is compromised, for instance because of interference or low antenna sensitivity.

This mode of operation, however, entails relatively high power consumption, since the high-power UHF transmitter is required to operate every one or two seconds. An alternative approach allows the active tag to remain in a deep power-down state almost permanently. To achieve this, the system requires a low-frequency (LF) wake-up receiver, which waits to receive an incoming signal from a nearby reader before initiating a UHF transmission. Low-frequency transmissions are little impaired by reflections from materials such as rock and liquids, and also support operation at a lower current than UHF transmissions. A well-designed LF receiver can operate continuously on a tiny current similar to a battery's leakage current, and thus has a negligible effect on the tag battery's life.

Now, however, the range of the system is the smaller of the receive range of the tag's LF receiver and the transmit range of the tag's UHF transmitter. Clearly this means the sensitivity of the LF receiver is of high importance. This low-power architecture can be evaluated in a reference design kit developed by ams. So how can this implementation of the low-power architecture described above ensure years of operation on a small battery?

### Architecture of the ams reference design: base station

The base station consists of an LF wake-up transmitter, a 2.4GHz RF transceiver (the AS3940) and a microcontroller - see figure 1. The base station is powered via its USB interface. As stated above, the effective range of the system is limited by the receive range of the tag's LF receiver. In order to maximize the base station's LF transmit range, a power management IC (PMIC) is used, supporting a high voltage input to the LF antenna. A low-power microcontroller (MCU) controls the operation of the LF and UHF protocols. The LF transmitter is based on discrete transistor circuitry, a matching network (MN) and the PCB antenna. LEDs indicate the status of the base station.

The base station's primary task is to continually transmit its LF wake-up pattern and its own identification data. It also collects return signal strength indicator (RSSI) information and identification data from tags that are within receive range, and communicates this to a host device or controller.

### Architecture of the ams reference design: active tag

The tag consists of an LF (15-150kHz) wake-up receiver, the AS3933, the AS3940 2.4GHz UHF frequency shift keying (FSK) transceiver, and an ultra-low power MCU - see figure 2. As stated above, the sensitivity of the wake-up receiver is a crucial factor in determining the effective range of the complete system. This is addressed in a clever design which takes advantage of the AS3933's three-channel input. In the challenging applications to which active RFID technology is suited, the orientation between the base station and the active tag is normally not fixed. The ams reference design thus uses a three-dimensional antenna system, with an antenna in each of the x, y and z axes each feeding one of the device's inputs. These three LF coils are combined in a single package. The AS3933 offers typical receive sensitivity of 80µVrms.

The UHF transmit path is implemented via the 2.4GHz transceiver with its

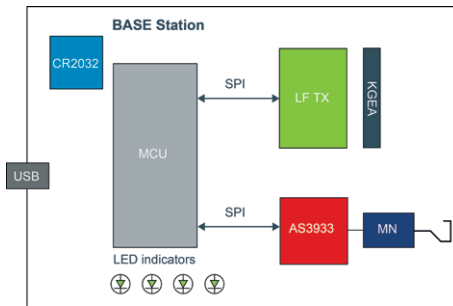

Fig. 1: ams active RFID reference design – base station block diagram.

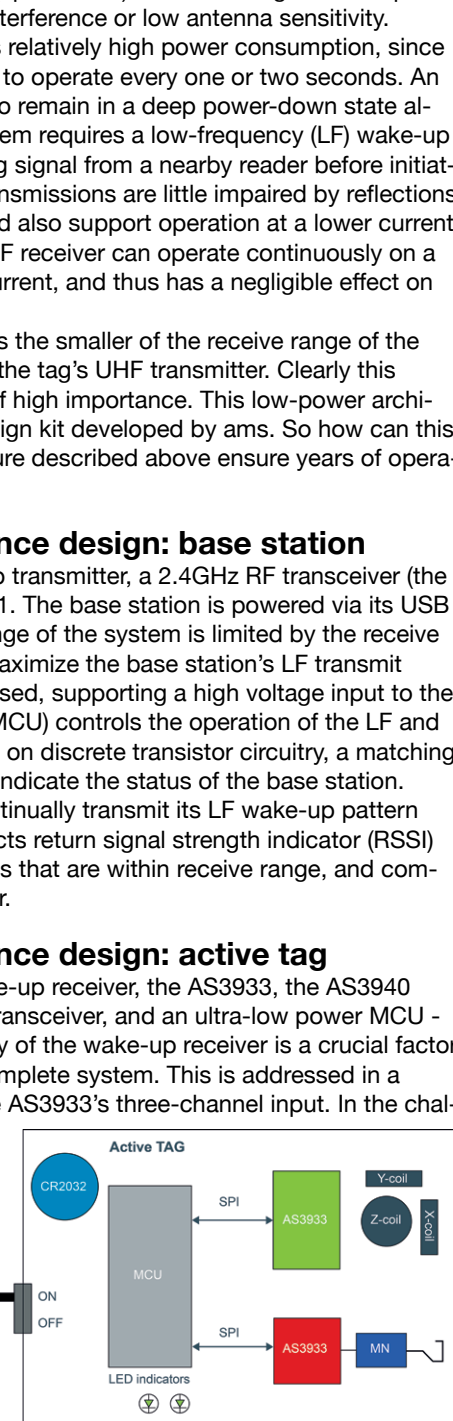

Fig. 2: ams active RFID reference design – active tag block diagram.

# PICO

## Surface Mount and Plug-In

## 400 / 800 Hz Transformers

Now...

up to

150

Watts



- 0.4 Watts to 150 Watts Power Transformers
- 115V/26V-400/800 Hz Primary
- Secondary Voltages 2.5V to 300V
- Manufactured to MIL-PRF 27 Grade 5, Class S, (Class V, 155°C available)
- Surface Mount or Plug-In
- Smallest possible size

See Pico's full Catalog immediately  
[www.picoelectronics.com](http://www.picoelectronics.com)



## PICO Electronics, Inc.

143 Sparks Ave. Pelham, N.Y. 10803

E-Mail: [info@picoelectronics.com](mailto:info@picoelectronics.com)

### Pico Representatives

Germany

ELBV/Electroniche Bauelemente Vertrieb

E-mail: [info@elbv.de](mailto:info@elbv.de)

Phone: 0049 89 4602852

Fax: 0049 89 46205442

England

Ginsbury Electronics Ltd.

E-mail: [rbennett@ginsbury.co.uk](mailto:rbennett@ginsbury.co.uk)

Phone: 0044 1634 298900

Fax: 0044 1634 290904

matching network (MN) and the PCB antenna. The LEDs operate as status indicators. In a system based on this reference design, an active tag can be expected to operate for a typical period of three years on a small CR2032 coin cell.

### System operation

The base station works in the following manner. The MCU initializes the LF wake-up receiver and the UHF transceiver with updated register settings. It then transmits the LF wake-up signal. After the LF transmission, the MCU switches the 2.4GHz transceiver to receive mode, waiting for active tags to respond. When a tag responds, it needs first to be temporarily paired to the base station. Once the devices are paired, one streaming data packet is expected. The tag's ID and RSSI information are contained in this packet. (If pairing is not accomplished, the base station will issue a second temporary pairing command after a period of time.) As soon as the packet has been streamed, the base station switches back to receive mode, waiting for another tag to respond.

The tag's operation mirrors that of the base station. On power-up, the MCU initializes the LF wake-up receiver and the UHF transceiver. The RC oscillator of the LF wake-up receiver is calibrated and the 3D antenna is automatically tuned by the AS3933. After this, the tag goes into deep sleep mode, waiting for an LF wake-up signal. Once a wake-up signal is received, the device checks that its pattern corresponds to its reference

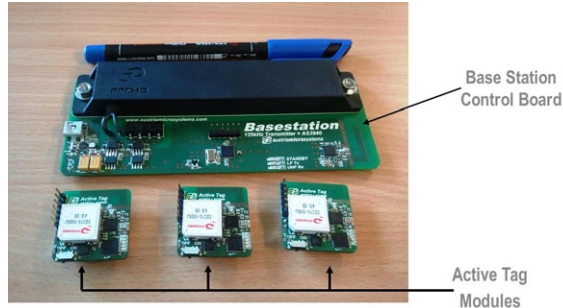

Fig. 3: the ams active RFID demonstration system.

pattern. It then generates an external interrupt to bring the MCU out of sleep mode. The MCU reads the RSSI and the base station ID contained in the LF signal. The tag will have a defined UHF transmission time slot assigned to its ID. To conserve power, the tag goes into sleep mode again until this time slot arrives. During the reserved time slot, the tag establishes a 2.4GHz connection with the base station, pairs with it and streams a data packet. Afterwards, the tag goes into sleep (LF receive) mode again.

### A low-power active RFID implementation

The advantage of the architecture described above is its ultra-low power consumption, the result of keeping the UHF transmitter in almost permanent power-down mode. This is enabled through the use of an LF wake-up receiver, the AS3933, which features a Manchester decoding capability. This allows the implementation of pattern recognition, so that the system avoids false wake-up calls generated by noise or interference. Thus the AS3940 UHF transceiver only operates when in the vicinity of a base station. The rest of the time, the tag draws just a few microamps.

As well as achieving outstandingly low power consumption, the highly integrated design is also small and has a low bill of materials - see figure 3. It has been successfully implemented in a number of end products, including access control and real-time location systems, and in passive keyless entry systems.

## Enhanced RFID realizes its full potential

By Victor Vega

FROM ADDING VISIBILITY TO the production process, through work-in-process manufacturing techniques, to adding accountability and speed to the movement of finished products through the supply chain, RFID has already changed the way manufacturers of electronics operate. But a number of challenges and shortcomings have limited the benefits the technology delivered.

For example, product housings made of metallic or other types of conductive materials often present an obstacle when using off-the-shelf RFID labels, because the surfaces block the RF signal transmitted by readers and make the tags difficult to read. Additionally, an RFID label attached to the exterior surface of a product can easily be found and removed - a weakness that could be exploited in order to divert goods to the grey market or disassociate a product from its warranty records.

What's more, applying RFID tags to the exterior surface of electronic products after they've already been manufactured robs the manufacturer of the added visibility and control the technology could provide throughout the entire manufacturing process.

NXP's UCODE I<sup>2</sup>C technology, recently incorporated into the Murata Magicstrap RFID module family, is specifically designed to solve these issues. Ultimately, the tag improves the manufacturing process and product delivery by enabling enhanced

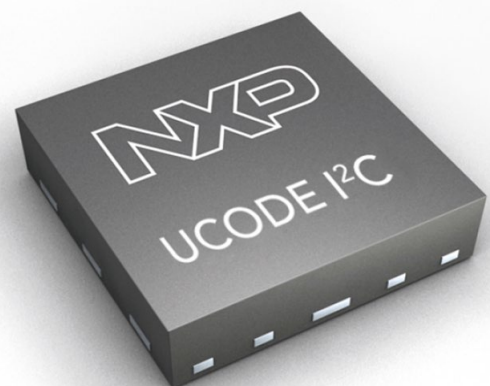

The UCODE I<sup>2</sup>C chip enables full product authentication from assembly lines to retail shelves.

customization (languages, features and functionality), theft/brand protection, and the ability to wirelessly track or trace products throughout the entire product lifecycle.

### Reliable track and trace

As the UCODE I<sup>2</sup>C chip is soldered to the PCB, it stays in the product over its full lifecycle. This means that the integrated tag enables a work-in-process tracking system that ensures fast, error-free assembly throughout production. This also enables it to provide relevant data at the recycling stage, delivering proof of compliance to the WEEE directive and reducing associated costs.

Victor Vega is RFID solutions director at NXP Semiconductors - [www.nxp.com](http://www.nxp.com) - He can be reached at [victor.vega@nxp.com](mailto:victor.vega@nxp.com)

## Protecting brand aesthetics

When used in consumer electronics goods, the UCODE I<sup>2</sup>C chip removes the burden of finding a way to apply an RFID tag to the product's exterior without compromising aesthetics. An integrated RFID solution allows for streamlined designs that can do away with conventional bar-labels, etched serial numbers or the need to open devices to access internal bar codes, protecting products from both damage and tampering.

Based on passive UHF RFID standards, data can be read or written wirelessly into the memory of the tag using a standard UHF reader, even while the device or appliance is switched off. Practically, this means that an electronics product can be configured for different languages and markets, or personalized while packed in the factory sealed carton – this includes importing gift certificates and even personalized messages/eCards for that special touch.

By removing the need to configure products during assembly or requiring power, OEMs can realize significant savings in manufacturing and logistics costs by responding precisely to regional, seasonal, model and customer demand.

## Theft protection

The UCODE I<sup>2</sup>C can be configured such that if the device in which it is embedded – for example, a motherboard – is tampered with, the chip can report a breach, along with its unique identification during its next RF transmission. This feature would help root out fraudulent activity such as the practice of purchasing high-value electronics, swapping out the original components for lower-grade versions – or even replacing them with dead weight rather than electronics – then returning the product while it's under warranty and selling the original, high-value components on the black market.

The technology can also help retailers authenticate legitimate returns, making warranty processing and product returns easier and more accurate. In these scenarios, the retailer would use the embedded RFID tag to identify a product that is returned, either for repair or as a product return or exchange. Once the tag number is captured, the retailer can use it to access the original sales record and warranty, removing any doubt as to whether the product was legitimately obtained.

## On-board security

The features and functions of the UCODE I<sup>2</sup>C offer all the basic EPC Gen 2 capabilities, including password protection and cloaked viewing for instances where data is not intended for public viewing. In addition, it offers added features such as a status flag bit, used in combination with an RFID security system to trigger an alarm if an item is removed from a store without being purchased. Furthermore, the UCODE I<sup>2</sup>C chip is the foundation of an EPC Gen 2 / ISO 18000-6c tag accepted worldwide and compatible with existing Gen 2 infrastructure.

## Mifare NFC mini reader USB development platform

Elatec RFID Systems has released a USB development platform for its Mifare NFC Mini Reader (13.56MHz) that allows OEMs and system integrators to quickly and simply integrate the compact RFID reader/writer unit into a proprietary application.



The Mifare NFC Mini Reader is a compact, low-cost reader/writer unit measuring 33x30mm with an integrated high frequency antenna. The device is particularly well-suited for mobile and industrial applications thanks to its minimal power consumption and extended operating temperature range from -25 to +80°C. The developer kit for the reader supports FTDI drivers for Windows, Linux and Mac, Windows CE .NET and Android. It includes a quick start guide, USB cable, software package and two

Mifare cards. The Mifare NFC Mini Reader requires minimal disk space and lower power, which makes it particularly well-suited for integration directly on a PCB of a machine or mobile computer. The module features four user-configurable inputs or outputs. It includes a secure access module connection for use in security and cryptography applications.

**Elatec RFID Systems**  
[www.elatec-rfid.com](http://www.elatec-rfid.com)

# PICO

- Over 2500 Std. DC-DC Converters
- Surface Mount
- From 2V to 10,000 VDC Output
- 1-300 Watt Modules
- Isolated/Regulated/Programmable Models Available
- Military Upgrades Available
- Custom Models, Consult Factory

See full Catalog immediately  
[www.picoelectronics.com](http://www.picoelectronics.com)



**PICO** Electronics, Inc.

143 Sparks Ave. Pelham, N.Y. 10803

E Mail: [info@picoelectronics.com](mailto:info@picoelectronics.com)

**Pico Representatives**

Germany

**ELBV/Electronische Bauelemente Vertrieb**

E-mail: [info@elbv.de](mailto:info@elbv.de)

Phone: 0049 89 4602852

Fax: 0049 89 46205442

England

**Ginsbury Electronics Ltd.**

E-mail: [rbennett@ginsbury.co.uk](mailto:rbennett@ginsbury.co.uk)

Phone: 0044 1634 298900

Fax: 0044 1634 290904

## Middleware enables cost-effective integration of RFID hardware

The Ha-VIS middleware from Harting provides easy and cost-effective integration of RFID hardware into existing software systems, enabling users to operate Ha-VIS RFID reading devices to process the transponder-supplied information without the need for any programming. The new system provides operators with the means to implement automation of the lowest field level into existing processes without the need for years of experience of RFID systems. The Ha-VIS middleware operates with a wide selection of data formats including XML, CSV and MySQL - enabling the immediate use of information. It also meets the requirements of the EPC standard ALE 1.1, allowing it to not only read RFID transponders but also write to them in conformity with the standard. The ability to integrate RFID hardware in an industry-standard environment without the need for programming leads to customer benefits in terms of ease of use and cost-effectiveness, making it easy to implement the rapid introduction of RFID into the company environment.

**Harting**

[www.harting.com](http://www.harting.com)

## Micropower fuel gauge reduces quiescent current by 4x and size by 3x

Maxim Integrated Products has begun sampling the MAX17048, the industry's simplest low-power fuel gauge for Lithium-ion (Li+) batteries. Operating at 23  $\mu$ A, the battery

fuel gauge claims to use 4x less power than competitive devices and even less in micropower hibernate mode, in which the fuel gauge continues to operate. It needs only one external capacitor, not the multiple external devices of competitive devices, so it simplifies design, shrinks solution size by 3x, and reduces costs. The fuel gauge is ideal for portable battery-powered applications where size, cost, and power are critical, such as smartphones, wireless handsets, and mobile accessories, including Bluetooth headsets, portable speakers, fitness devices, and Wi-Fi routers. The MAX17048 features the proven ModelGauge algorithm and does not require coulomb counting to report accurate battery state-of-charge, thus extending runtime. The MAX17048 functionality is also integrated into the company's TINI Power System-on-Chip (SoC) to make it easier to upgrade designs to more complex systems. The device's ModelGauge algorithm provides accurate state of charge and compensates for temperature and load variation. The algorithm also eliminates the need for the current-sense resistor required in competing coulomb-counting fuel gauges. The MAX17048 automatically detects when the battery enters a low-current state and switches into a low-power 4  $\mu$ A hibernate mode, while still providing accurate fuel gauging. The IC automatically exits hibernate mode when the system returns to active state.

**Maxim Integrated**

[www.maximintegrated.com](http://www.maximintegrated.com)

## To win: two portable digital 14x magnifiers



This month, Vision Engineering is giving away two of its recently launched CamZ digital magnifiers. Worth £696 each, the instruments are specifically designed to provide portable magnification for easy inspection and documentation. The CamZ offers up to 14x magnification, stores up to 100 images, and has grids and cursors for X and Y dimensioning. With a 4.3" diagonal high resolution colour display, simple button operation and image capture/download capability, CamZ is suitable for roving inspection tasks, documenting faults, or for inspecting immobile subjects. Optimised for macro imaging, CamZ benefits from dual LED illumination, and the sensor video captures 30 frames a second for a crisp, high contrast image. Designed for ergonomic one-handed operation, the 200x80x30mm CamZ weighs only 225 grams and comes in a durable carrying case, with a USB transfer cable and a charger included.



**Check the reader offer online at**

[www.electronics-eetimes.com](http://www.electronics-eetimes.com)

## CMOS shutter camera delivers 1.3Mpixel images at 60 frames per second

The Blackfly camera model BLFY-PGE-13E4 released by Point Grey features a 1.3Mpixel, 60fps, CMOS global shutter sensor available in both monochrome and color. It draws less than 2W of power and comes in a light GigE POE camera package. Future Blackfly models include 0.5 and 0.9 MP CCD resolutions with excellent quantum efficiency and wide dynamic range. The BFLY-PGE-13E4 model uses the EV76C560 CMOS sensor from e2v which uses a global shutter readout architecture. Global shutter is critical to prevent geometric distortion when capturing images of fast moving objects. The CMOS pixel design on the other hand addresses blooming and smearing artefacts caused by bright sources or reflections in the camera's field of view. The Blackfly BFLY-PGE-13E4 model satisfies industry demand for global shutter CMOS ideal for cost sensitive applications in automation, 3D imaging or license plate recognition. Point Grey's Blackfly camera measures just 29x29x30mm and provides a unique set of features including power over Ethernet, temperature and status monitoring, in-field updatable firmware, color interpolation, look up table, gamma correction, pixel binning functionality, and much more.



**Point Grey**

[www.ptgrey.com](http://www.ptgrey.com)

## Infrared thermometers with extended temperature ranges of -40° to 3000°C

Ircon has introduced the 7V Series of infrared sensors for demanding industrial environments. The PROC-7 processor box allows full sensor operation through a push button panel and is part of a full line of accessories offered for the Modline 7 series thermometers. The Modline 7 is a rugged, IP65 (NEMA 4) sealed sensor system with the flexibility to meet nearly any continuous temperature monitoring and control requirement. The thermometers are used in a wide range of industrial applications, including semiconductor manufacturing, metals processing, furnace refractory, primary and secondary glass, as well as plastics thermoforming. The Modline 7 offers exceptional versatility with extended temperature ranges (-40° to 3000°C), high-resolution optics and fast response times. The thermometer's sensing head can operate as a stand-alone sensor, providing simultaneous analog and digital outputs of process temperatures. Motorized focus control and both through-the-lens and laser sighting are standard on all units. The new thermometer's intuitive sensor design features integral water-cooling in a stainless steel enclosure. The high-temperature water jacket with integrated air purge capability reduces installation and setup time and is intended for use in ambient temperatures up to 315°C.

**Ircon**  
[www.ircon.com](http://www.ircon.com)



## Dual 16-bit, 1.6-GSPS DAC synthesizes high-quality wideband signals

Analog Devices, Inc. has introduced the AD9142 dual-channel, 16-bit, 1.6-GSPS D/A converter, which supports high data rates and complex modulation schemes required in communications, test and instrumentation, and defense and aerospace systems. The combination of programmable interpolation rate, high sample rates, and fine NCO modulation capability gives system designers flexibility when choosing D/A converter output frequencies. This is especially helpful in meeting four- to six-carrier GSM transmission specifications and other communications standards. Operating with the on-chip PLL (phase-locked loop) at a D/A converter output frequency of 200 MHz, the AD9142 delivers a 79-dB ACLR (adjacent-channel leakage ratio) for six-carrier GSM applications. The AD9142 includes integrated interpolation filters with selectable interpolation factors of 2, 4, and 8. The dual D/A converter data interface supports word and byte load allowing customers to reduce input pins on lower data rates to save board space, power and cost. The AD9142 is available in a space-saving 72-pin LFCSP (lead-frame chip-scale package).

**Analog Devices**  
[www.analog.com](http://www.analog.com)

Nuremberg, Germany  
26 – 28.2.2013

*we are the future*

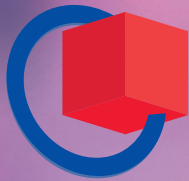

# embedded world 2013

## Exhibition & Conference

... it's a smarter world

Register now for your free entrance ticket:

[embedded-world.de](http://embedded-world.de)

## Experience the future.

embedded world presents the latest technical developments and shows tomorrow's trends today. Make sure of your knowledge lead now!

**Exhibition organizer**  
NürnbergMesse GmbH  
Tel +49 (0) 9 11.86 06-49 12  
[visitorservice@nuernbergmesse.de](mailto:visitorservice@nuernbergmesse.de)

**Conference organizer**  
WEKA FACHMEDIEN GmbH  
Tel +49 (0) 89. 255 56-13 49  
[info@embedded-world.eu](mailto:info@embedded-world.eu)

**Media partners**  
**MEDIZIN**  **elektronik**  
Fachmedium für Elektronik in der Medizintechnik  
**elektroniknet.de**  
**computer-automation.de**  
**energie-und-technik.de**  
**MEDIZIN**  **elektronik.DE**

**DESIGN & ELEKTRONIK**  
KNOW-HOW FÜR ENTWICKLER

**Markt & Technik**  
Die unabhängige Wochenzeitung für Elektronik  
**Elektronik**  
Fachmedium für industrielle Anwender und Entwickler

**Elektronik automotive**  
Fachmedium für professionelle Automobiltechnik  
**ENERGIE & TECHNIK**  
Fachmedium für Energieeffizienz  
**Computer & AUTOMATION**  
Fachmedium über Automatisierungstechnik

**NÜRNBERG MESSE**

## High current filter chokes with inductance range from 1microH up to 15mH

Now available from Total Frequency Control, the type DRH high current filter chokes come with an inductance range from 1microH up to 15mH with a maximum current density of

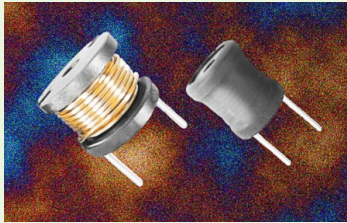

8.0A/mm<sup>2</sup> over an operating temperature of -20°C to +80°C. Designed for use in switching regulated power supply applications, low profile and self-leading, the finished product is varnish coated or insulated with UL

shrink-sleeving. The inductors also feature a useful central hole to facilitate automatic mechanical mounting. Power density dictates the dimensions which vary from 3 to 5mm in height and 21 to 28mm in diameter. The product exhibits low DCR values and high saturation currents.

**Total Frequency Control**  
[www.tfc.co.uk](http://www.tfc.co.uk)

## Reference design for advanced browsing control of TVs and set-top boxes

The nRFready Smart Remote 2 unveiled by Nordic Semiconductor is a complete hardware and software reference design featuring a multi-touch touchpad, 6-axis motion sensing, and



full QWERTY keyboard. The reference design leverages Nordic's latest multi-protocol nRF51822 SoC to offer simultaneous single chip Bluetooth low energy and Nordic 2.4GHz

proprietary Gazell RF protocol support, and provides a unique, feature-rich platform for developing remote controls for the latest Internet-enabled and Web 2.0 digital TVs and set-top boxes. Prime application examples include audio, video, gaming, web browsing, social media, and online shopping, where an essential ingredient to the success and adoption of these services by end users is the remote control, which can spell the difference between frustration and a rich, intuitive, and engaging end-user experience. Designed specifically to deliver the latter, the nRFready Smart Remote 2 features a multi-touch enabled TouchPad from Synaptics, a miniaturized QWERTY keyboard, a 6-axis motion sensing solution from Invensense, and an ultra-low power accelerometer from STMicroelectronics. The inclusion of Nordic's latest nRF51822 multi-protocol SoC (see 'About nRF51822' below) allows remote control manufacturers to bring products to market that can simultaneously and adaptively support Bluetooth low energy (via the HID over GATT profile) and proprietary 2.4GHz wireless technology in the same product form factor, using identical data formats over the wireless link to minimize design complexity, and without requiring any firmware changes. This offers developers a high level of commercial protection against future consumer technology trends by allowing them to offer a maximum range of alternative options to their customers. The nRFready Smart Remote 2 reference design even features an IR (Infrared) LED that can be used to add support for legacy IR-controlled equipment too.

**Nordic Semiconductor**  
[www.nordicsemi.com](http://www.nordicsemi.com)

## Bluetooth low energy software stack supports over-the-air downloads and multiple stacks

Texas Instruments Incorporated has released the company's newest BLE-Stack 1.3 software to support continued development and enhancement of Bluetooth low energy. TI's BLE-Stack 1.3 includes over-the-air firmware downloads (OAD), which enable updates to CC2540/1 firmware to be downloaded from a central device, such as a phone, tablet or PC onto the CC2540/1 system-on-chip (SoC) directly over the RF link. OAD support helps customers save time and simplify the software upgrade process, leaving more time to design and create new Bluetooth low energy devices and applications. Additionally, for customers using Bluetooth low energy and proprietary implementations, TI's Boot Image Manager (BIM) allows multiple firmware stacks to reside on a single CC2540/1 SoC. BIM enables an end-product to support two different Bluetooth low energy stacks or a single Bluetooth low energy stack and a single 2.4GHz proprietary stack. The new software features are further supported by sample applications with extensive profile support and include upgraded network processor UART and SPI interfaces for improved power management control. To further the development of new Bluetooth low energy applications, the new BLE-Stack 1.3 also runs on TI's SensorTag development kit and Mini-kit. The SensorTag development kit is supported by OAD, iOS app and the Bluetooth low energy device monitor.

**Texas Instruments**  
[www.ti.com](http://www.ti.com)

## Surface-mount bidirectional transient voltage suppressors with surge capability to 3kW

Vishay Intertechnology has introduced a new series of surface-mount TRANSZORB bidirectional transient voltage suppressors (TVS) in the SMC DO-214AB package. For automotive and telecom applications, SMC3K series devices feature high surge capability to 3 kW at 10/1000  $\mu$ s. Offering twice the surge capability of conventional 1.5 kW devices in SMC packages, the new SMC3K series devices increase design flexibility and compatibility. In addition, the TVS' new low-stress, symmetric lead frame designs provide the high reliability



required for automotive applications. Designed to protect sensitive electronic equipment against voltage transients induced by system inductive load switching and lightning, the AEC-Q101-qualified devices are suitable for LNB and telecom power line lightning surge protection, and for automotive motor and battery power line inductive surge protection. The SMC3K series consists of 19 TVS devices with stand-off voltages from 22 V to 78 V. The devices offer a peak pulse surge current from 23.8 A to 84.5 A, maximum clamping voltage from 35.5 V to 126 V, fast response times, low incremental surge resistance, and operating temperature from - 55 to + 150°C. The SMC3K series meets the MSL Level 1 standard, per J-STD-020, LF maximum peak of 260°C.

**Vishay Intertechnology**  
[www.vishay.com](http://www.vishay.com)



## Farnell element14 becomes local distributor in Poland

Farnell element14 is continuing the organization's drive into the Polish market by solely dealing direct with customers in its supply of electronic components and engineering solutions. The organization has recently re-aligned its business in the region for customers to buy direct from local language websites in a move which ensures they receive the best possible experience. Customers are able to directly access 500,000 products in local currency prices available on next day delivery. The development of the new outbound telesales and telemarketing center in Krakow was the first phase of the re-alignment in October 2012, providing best in class service in 22 European languages to Farnell element14's new and existing customers across the continent. The center is part of a strategic investment representing Farnell element14's commitment to delivering a superior multi-channel service that meets the needs of its customers.

**Farnell element 14**

[www.element14.com](http://www.element14.com)

## 1-Source Electronic Components launches online store with hard-to-find electronics

After 11 years in business, with a focus on sourcing hard-to-find electronic components for electronics manufacturers, 1-Source Electronic Components announced the launch of an online store. The web store, which has been integrated into 1-Source's existing website, features online shopping with extensive product information. The 1-Source web store features more than 3 million different electronic parts and related products.

Of these, 500,000 are franchised items with current pricing, product images, detailed specifications, and data sheets.

**1-Source Electronic Components**

[www.1SourceComponents.com](http://www.1SourceComponents.com)

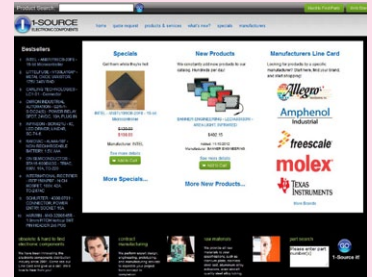

## Waterproof AC fans for harsh conditions

New from Aerco, the ADDA AA1282 range of waterproof AC fans allows designers to use readily available AC power for a fan that provides IP55 protection levels and has passed stringent salt water spray tests. Using high performance packaging, infusion technology and parylene coating, these fans are highly suitable for use in freezers, refrigerated rooms, food processing plants and all applications that use spray-down cleansing techniques. Built in a frame size of 120x120x38mm, the fans are thermally stable so can be used in a very wide temperature range from -10°C to +70°C. The airflow capacity is 43 litres/s with a product life of over 50,000 hours.



**Aerco**

[www.aerco.co.uk](http://www.aerco.co.uk)

## 15-inch industrial display with 450cd/m<sup>2</sup> of brightness and a contrast ratio of 1000:1

With the Basic Industrial Line by Chi Mei Innolux (CMI), Gleichmann Electronics is offering a new inexpensive high-quality family of displays especially for cost-sensitive indoor industrial applications. The first two members of the family, which are identical to the same-sized Classic Industrial Line models except for the integrated backlight unit, are the 12.1" G121AGE-L03 SVGA display with an all-round viewing angle of 89°, 450 cd/m<sup>2</sup> brightness and a contrast ratio of 1000:1 and also the 15" G150AGE-L05 XGA display with horizontal and vertical viewing angles of 160° and 140° respectively, brightness of 250cd/m<sup>2</sup> and a contrast ratio of 700:1.



**Gleichmann & Co. Electronics GmbH**

[www.msc-ge.com](http://www.msc-ge.com)

## Fully programmable smoke detector IC with integrated bus interface

MSC now offers the E520.32 programmable smoke detector IC from Elmos Semiconductor, a device that includes all active electronic components of a network capable smoke detector. The E520.32 combines a configurable 200 mA driver for the transmitter LED, a high impedance input for the voltage conversion to the receiver diode and a 2-wire bus interface. It is equipped with 4 KByte of flash ROM and 32 Byte of EEPROM. In addition to a wide photo input current range of 1.5nA to 45nA, the device draws only 88 µA. The fast responses of the amplifier and the 10-bit A/D converter allow short transmitter pulses at a high detection rate. Furthermore, due to the narrow band pass filter characteristics of the amplifier, interference signals and false alarms are avoided. The chip is designed to operate from -55 to +85°C and comes in a SOIC14 package.



**MSC Vertriebs**

[www.msc-ge.com](http://www.msc-ge.com)

## GaAs hybrid amplifiers for distribution nodes

Richardson RFPD is now distributing two new GaAs hybrid amplifiers from Anadigics, the ACA2786 and ACA2788, each consisting of two pairs of parallel amplifiers that are optimized for very low distortion and noise figure with input and output transient voltage protection. These rugged devices include an integrated ring wave surge protection, as well as superior ESD protection of over 7kV, and are offered in standard SOT-115J packages. They are designed for distribution nodes, system amplifiers, and line extenders in CATV HFC distribution systems. Both devices have an operating range of 40MHz to 1GHz, with respective gains of 25dB and 28dB. They operate from a 24V supply and draw 430mA.



**Richardson RFPD**

[www.richardsonrfpd.com](http://www.richardsonrfpd.com)

**PUBLISHER**

André Rousselot  
+32 27400053  
andre.rousselot@eetimes.be

**EDITOR-IN-CHIEF**

Julien Happich  
+33 153907865  
julien.happich@eetimes.be

**EDITORS**

**Nick Flaherty**  
+44 7710236368  
nick.flaherty@eetimes.be  
**Christoph Hammerschmidt**  
+49 8944450209  
chammerschmidt@gmx.net

**CONTRIBUTING EDITORS**

**Paul Buckley**  
+44 1962866460  
paul@activewords.co.uk  
**Jean-Pierre Joosting**  
+44 7800548133  
jean-pierre.joosting@eetimes.be

**CIRCULATION & FINANCE**

**Luc Desimpel**  
luc.desimpel@eetimes.be

**ADVERTISING PRODUCTION & REPRINTS**

**Lydia Gijsegom**  
lydia.gijsegom@eetimes.be

**ART MANAGER**

**Jean-Paul Speliers**

**ACCOUNTING**

**Ricardo Pinto Ferreira**

**REGIONAL ADVERTISING REPRESENTATIVES**

Contact information at:  
<http://www.electronics-eetimes.com/en/about/sales-contacts.html>

**EUROPEAN BUSINESS PRESS SA**

7 Avenue Reine Astrid  
1310 La Hulpe  
Tel: +32 (0)2 740 00 50  
Fax: +32 (0)2 740 00 59  
[www.electronics-eetimes.com](http://www.electronics-eetimes.com)  
VAT Registration: BE 461.357.437  
RPM: Brussels  
Company Number: 0461357437

© 2013 E.B.P. SA

ELECTRONIC ENGINEERING TIMES EUROPE is published 11 times in 2013 by European Business Press SA, 7 Avenue Reine Astrid, 1310 La Hulpe, Belgium  
Tel: +32-2-740 00 50 Fax: +32-2-740 00 59  
email: [info@eetimes.be](mailto:info@eetimes.be) VAT Registration: BE 461.357.437  
RPM: Nivelles. Volume 15, Issue 1 EE Times P 304128  
It is free to qualified engineers and managers involved in engineering decisions - see:  
<http://www.electronics-eetimes.com/subscribe>  
Copyright 2013 by European Business Press SA.  
All rights reserved. P 304128

# LAST WORD

## Driving innovation into the global automotive supply chain

By Andrew Ashby

**THE UK IS A HOT-BED** of innovative automotive technology companies, spurred by a thriving motor-racing community as well as larger Tier1 (T1) and research & development organisations with specialist automotive expertise. However the route to market for these companies and their disruptive new ideas has always been a difficult one, existing as it does in a tightly controlled global automotive supply chain. Indeed they face a couple of significant challenges:

Firstly, T1 suppliers have traditionally had to constrain the content and the pace of new innovation releases to satisfy their customers' (the OEM manufacturers) now ageing procurement regimes and quality expectations. Influenced by these significant commercial pressures, the T1 suppliers often have no choice but to take the lowest cost, lowest risk path to satisfying their customers' requirements. This policy has inadvertently restricted car manufacturers' exposure to new ideas and stifled the flow of new innovation into their products. It is worth observing that giving them better exposure to these technologies creates a natural 'pull-through' demand as they can then place new expectations on their T1 suppliers to deliver them.

Secondly and perhaps even more of a challenge today, is that when it comes to enabling consumers in their vehicles with the types of features they have come to love on their smart portable devices, the automotive industry is its own worst enemy. Frankly, as it stands, it is unable to deliver the technologies fast enough; with its current processes in place, it can take up to seven years for a new technology to make it onto the road in a new vehicle. Consumer devices span three generations in this time and in the current market are almost guaranteed to render the OEM's solution out of

date by the time it reaches the end user.

So, the astute OEMs and their T1 suppliers recognise that they have to change their processes fast to keep their vehicle content attractive to the end consumer. In fact they need to construct a whole new 'soft' delivery mechanism if they are to respond to and survive such rapid progress in consumer demand.

Combine these two characteristics and you have a serious problem. If it is not solved swiftly, the industry can be sure that the consumer smartphone and tablet suppliers will eat its breakfast and rapidly come to dominate the user interface, inside the car as well as out.

So the question is, how do they do this? Achieving a mini revolution in the automotive supply chain is a massive challenge as it is a 'very big ship to turn'. How do they embrace new ideas and change their business models to better access the new innovations and to deliver them much faster than ever before?

During 2012 a diverse group of interested parties has come together in an open forum environment, to directly challenge these questions. Often the greatest innovations are achieved when different skill-sets are bought together and with this in mind the NMI - [www.nmi.org.uk](http://www.nmi.org.uk) - has created the Automotive Electronic Systems Innovation Network (AESIN). Driven by trusted and credible international parties active in the UK electronics and automotive industries, the consortium is by automotive standards, a ground-breaking group, facilitating direct engagement between advanced technology providers and vehicle manufacturers, industry consultants and T1 suppliers. Several of these parties are competitors in their respective spaces, going out of their way and putting time aside to address these challenges on behalf of 'UK Electronics Plc'. Already there are discussions ranging from the driving of new industry standards to the creation of flexible, fast-refresh software platforms for configurable dashboard technologies, so the traction and interaction is already producing results.



Andrew Ashby is Automotive Business Development Manager at product innovation, business and design consultancy Plextek - [www.plextek.co.uk](http://www.plextek.co.uk)

# EET Search

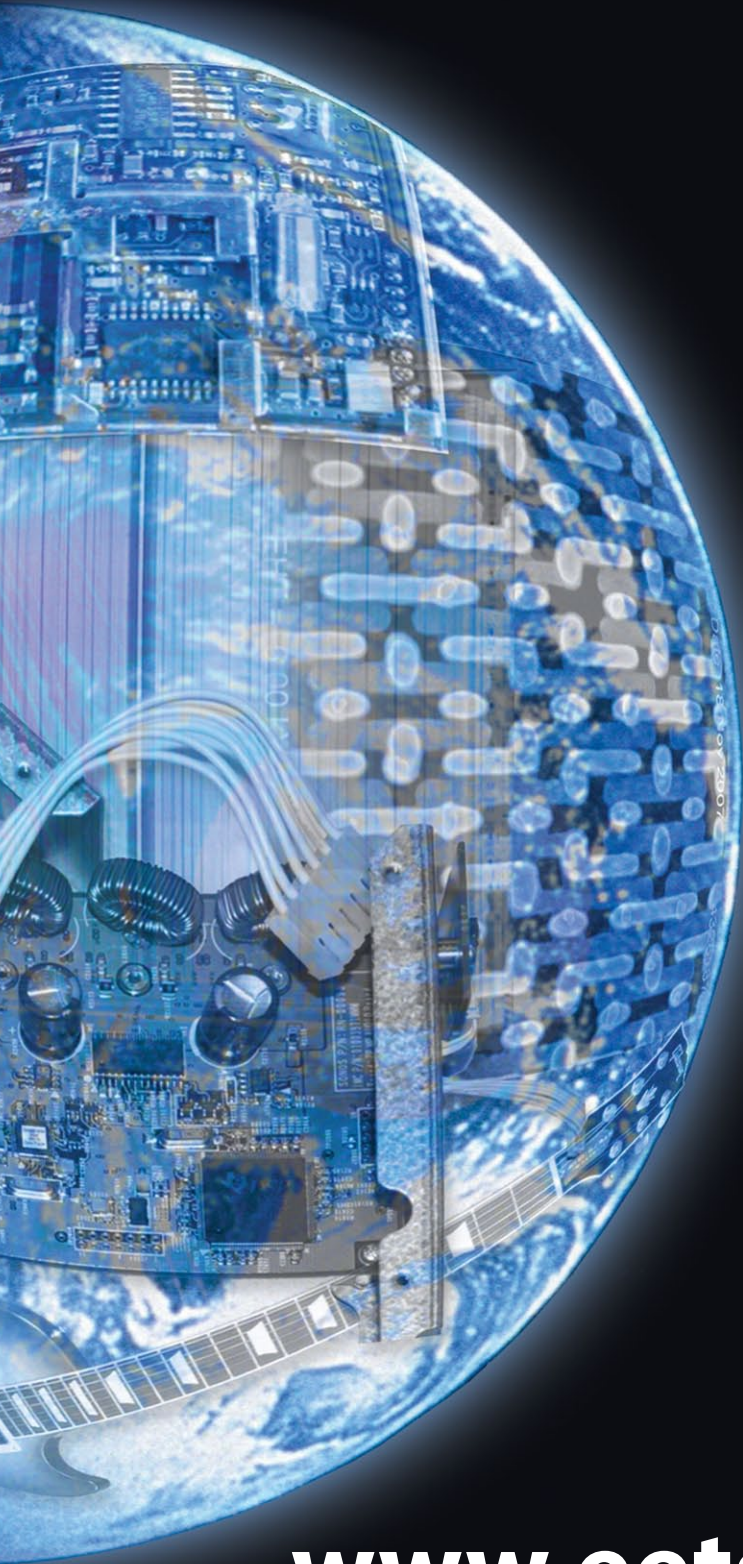

**- searches all  
electronics sites**

**- displays only  
electronics results**

**- is available on  
your mobile**

**[www.eetsearch.com](http://www.eetsearch.com)**

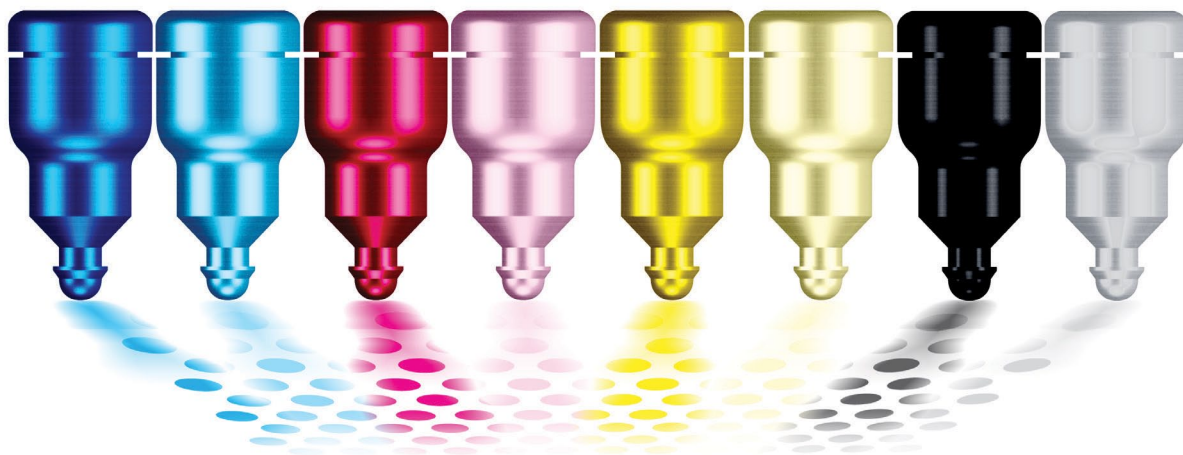

# Space Saver. Cost Saver.

## MP103FC Power Amplifier: Dual-Channel Design Delivers Space Savings, Cost Savings

### DRIVE MULTIPLE PIEZOELECTRIC LOADS WITH SPEED, CURRENT AND VOLTAGE

The MP103FC from Apex Microtechnology is a dual-channel power amplifier that is designed to drive multiple loads with a single device. With full power bandwidth rated for 230 kHz, the MP103FC is optimized for industrial applications requiring piezoelectric loads with more than one driver. This thermally enhanced module also features output current of up to 15 A PEAK per channel and a 30 V to 200 V power supply. A single MP103FC delivers high current, high voltage and high speed at a per unit cost savings that makes it the option of choice versus single amplifier solutions and discrete designs.

- Print head electronic drives for industrial ink jet printers

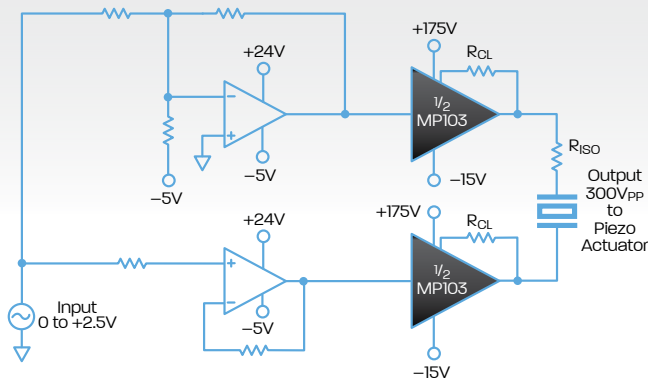

BRIDGE MODE PIEZOELECTRIC DRIVER  
(For Design Discussion Purposes Only)

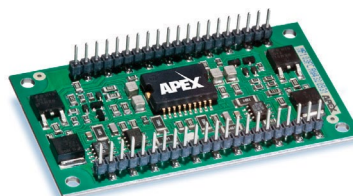

FC MODULAR 42-PIN DIP

Open Frame Product Technology  
(actual footprint 65.1mm X 42.5mm)

Power up at [www.apexanalog.com/eetemp103](http://www.apexanalog.com/eetemp103)

[apexanalog.com/eetemp103](http://apexanalog.com/eetemp103)

